



OWNER'S MANUAL

COMMERCIAL WASHER

Before beginning installation, read these instructions carefully. This will simplify installation and ensure that the washer is installed correctly and safely. Leave these instructions near the washer after installation for future reference.

MODEL

GCWP1069CS/GCWP1069QS/GCWP1069LS

GCWP1069CS2/GCWP1069QS2/GCWP1069LS2



P/No.: MFL67360455

www.lg.com

PRODUCT FEATURES

DIRECT DRIVE SYSTEM

The advanced brushless DC motor drives the drum directly without using a belt and pulley.

TILTED DRUM AND EXTRA LARGE DOOR OPENING

The tilted drum and extra large opening make it possible to load and unload clothing more easily.

ULTRA CAPACITY

The larger drum enables more tumbling action and greater centrifugal force, but also less tangling and wrinkling of the laundry. Heavier loads, such as king size comforters, blankets, and curtains can be washed.

SEE-THROUGH DOOR AND BIG DOOR

You can see the laundry throughout the cycle.

MAGNETIC DOOR PLUNGER

Safely and conveniently secure the door slightly ajar with the magnetic door plunger. This will promote air circulation and allow the interior of the machine to dry. To use this feature, after the load has been removed, do not close the door completely. When the magnetic door plunger comes into contact with the metal washer cabinet, it will secure the door slightly open allowing the interior of the washer to dry.

STAINLESS STEEL DRUM

Stainless steel drum offers extreme durability.

TUB CLEAN

Regular cleaning of the tub on a monthly basis using TUB CLEAN can help keep the tub clean and fresh.

IMPORTANT SAFETY INSTRUCTIONS

READ ALL INSTRUCTIONS BEFORE USE

⚠ WARNING

For your safety, the information in this manual must be followed to minimize the risk of fire or explosion, electric shock, or to prevent property damage, injury to persons, or death.

Your Safety and the safety of others are very important.

We have provided many important safety messages in this manual and on your appliance. Always read and obey all safety messages.

⚠ This is the safety alert symbol.

This symbol alerts you to potential hazards that can kill or hurt you and others.

All safety messages will follow the safety alert symbol and either the word DANGER, WARNING, CAUTION.

These words mean:

⚠ DANGER

You can be killed or seriously injured if you don't immediately follow instructions.

⚠ WARNING

You can be killed or seriously injured if you don't follow instructions.

⚠ CAUTION

You may be slightly injured or cause damage to the product if you do not follow instructions.

All safety messages will tell you what the potential hazard is, tell you how to reduce the chance of injury, and tell you what can happen if the instructions are not followed.

BASIC SAFETY PRECAUTIONS

⚠ WARNING

To reduce the risk of fire, electric shock, or injury to persons when using this appliance, follow basic precautions, including the following:

- Before use, the washer must be properly installed as described in this manual.
- Do not wash articles that have been previously cleaned in, washed in, soaked in, or spotted with gasoline, dry cleaning solvents, or other flammable or explosive substances, as they give off vapors that could ignite or explode.
- Do not add gasoline, dry cleaning solvents, or other flammable or explosive substances to the wash water. These substances give off vapors that could ignite or explode.
- Under certain conditions, hydrogen gas may be produced in a hot water system that has not been used for 2 weeks or more. HYDROGEN GAS IS EXPLOSIVE. If the hot water system has not been used for such a period, before using the washer, turn on all hot water faucets and let the water flow from each for several minutes. This will release any accumulated hydrogen gas. As the gas is flammable, do not smoke or use an open flame during this time.
- Do not allow children to play on or in the washer. Close supervision of children is necessary when the washer is used near children.
- Before the washer is removed from service or discarded, remove the door to prevent children from climbing inside.
- Do not install or store the washer where it will be exposed to the weather or freezing temperatures.
- Do not tamper with controls.
- Do not repair or replace any part of the washer or attempt any servicing other than as described in this manual. We strongly recommend that any service be performed by a qualified technician.
- See Installation Instructions for grounding requirements.
- ALWAYS follow the fabric care instructions supplied by the garment manufacturer.
- Do not place items exposed to cooking oil in your washer. Items contaminated with cooking oils may contribute to a chemical reaction that could cause a load to catch fire.
- Use fabric softeners or products to eliminate static only as recommended by the manufacturer.
- This washer is not designed for maritime use or for mobile installations such as in RVs, aircraft, etc.
- Turn off the water faucets and unplug the washer if the machine is to be left for an extended period of time, such as during vacations.
- Do not use to dry articles containing foam rubber or similarly textured rubber-like materials.
- Packaging material can be dangerous for children. There is a risk of suffocation! Keep all packaging from children.
- Always check the inside of the washer for foreign objects before loading laundry. Keep the door closed when not in use.
- Do not reach into the appliance if the tub or agitator is moving.
- WARNING : This product contains chemicals known to the State of California to cause cancer and birth defects or other reproductive harm. *Wash hands after handling.*

IMPORTANT SAFETY INSTRUCTIONS

READ ALL INSTRUCTIONS BEFORE USE

⚠ WARNING

For your safety, the information in this manual must be followed to minimize the risk of fire or explosion, electric shock, or to prevent property damage, injury to persons, or death.

GROUNDING INSTRUCTIONS

This appliance must be grounded. In the event of malfunction or breakdown, grounding will reduce the risk of electric shock by providing a path of least resistance for electric current. This appliance is equipped with a cord having an equipment-grounding conductor and grounding plug. The plug must be plugged into an appropriate outlet that is properly installed and grounded in accordance with all local codes and ordinances.

⚠ WARNING

Improper connection of the equipment-grounding conductor can result in risk of electric shock. Check with a qualified electrician or servicer if you are in doubt as to whether the appliance is properly grounded. Do not modify the plug provided with the appliance. If it does not fit the outlet, have a proper outlet installed by a qualified electrician. Failure to follow these warnings can cause serious injury, fire, electric shock, or death.

IMPORTANT SAFETY INSTRUCTIONS

READ ALL INSTRUCTIONS BEFORE USE

⚠ WARNING

For your safety, the information in this manual must be followed to minimize the risk of fire or explosion, electric shock, or to prevent property damage, injury to persons, or death.

SAFETY INSTRUCTIONS FOR INSTALLATION

⚠ WARNING

To reduce the risk of fire, electric shock, or injury to persons when using this appliance, follow basic precautions, including the following:

- **Refer to INSTALLATION INSTRUCTIONS for detailed grounding procedures.** Installation instructions are packed with the washer for installer's reference. If the washer is moved to a new location, have it checked and reinstalled by a qualified service technician. Failure to follow this warning can cause serious injury, fire, electric shock, or death.
- **Do not, under any circumstances, cut or remove the third (ground) prong from the power cord.** Failure to follow this warning can cause serious injury, fire, electric shock, or death.
- **For personal safety, this appliance must be properly grounded.** Failure to follow this warning can cause serious injury, fire, electric shock, or death.
- **The power cord of this appliance is equipped with a 3-prong (grounding) plug which mates with a standard 3-prong (grounding) wall outlet** to minimize the possibility of electric shock from this appliance.
- **This washer must be plugged into a 120 VAC, 60 Hz grounded outlet.** Failure to follow this warning can cause serious injury, fire, electric shock, or death.
- **Have the wall outlet and circuit checked by a qualified electrician to make sure the outlet is properly grounded.** Failure to follow this warning can cause serious injury, fire, electric shock, or death.
- **Where a standard 2-prong wall outlet is encountered, it is your personal responsibility and obligation to have it replaced with a properly grounded 3-prong wall outlet.** Failure to follow this warning can cause serious injury, fire, electric shock, or death.
- **Do not install on carpet. Install washer on a solid floor.** Failure to follow this warning can cause serious leak damage.
- **Do not remove ground prong. Do not use an adapter or extension cord. Plug into a grounded 3-prong outlet.** Failure to follow these warnings can cause serious injury, fire, electric shock, or death.
- **The washer should always be plugged into its own individual electrical outlet which has a voltage rating that matches the rating plate.** This provides the best performance and also prevents overloading house wiring circuits which could cause a fire hazard from overheated wires.
- **Never unplug your washer by pulling on the power cord.** Always grip plug firmly and pull straight out from the outlet. Failure to follow this warning can cause serious injury, fire, electric shock, or death.
- **Repair or immediately replace all power cords that have become frayed or otherwise damaged. Do not use a cord that shows cracks or abrasion damage along its length or at either end.** Failure to follow this warning can cause serious injury, fire, electric shock, or death.
- **When installing or moving the washer, be careful not to pinch, crush, or damage the power cord.** Failure to follow this warning can cause serious injury, fire, electric shock, or death.
- **The washer must be installed and electrically grounded by a qualified service person in accordance with local codes** to prevent shock hazard and assure stability during operation.
- **The washer is heavy. Two or more people may be needed to install and move the appliance.** Failure to do so can result in back or other injury.
- **Store and install the washer where it will not be exposed to temperatures below freezing or exposed to outdoor weather conditions.** Failure to follow this warning can cause serious leak damage.
- **Do not install the washer in humid spaces to reduce the risk of electric shock.** Failure to follow this warning can cause serious injury, fire, electric shock, or death.
- **To reduce the risk of injury to persons, adhere to all industry recommended safety procedures including the use of long sleeved gloves and safety glasses.** Failure to follow all of the safety warnings in this manual could result in property damage, injury to persons or death.

IMPORTANT SAFETY INSTRUCTIONS

READ ALL INSTRUCTIONS BEFORE USE

⚠ WARNING

For your safety, the information in this manual must be followed to minimize the risk of fire or explosion, electric shock, or to prevent property damage, injury to persons, or death.

SAFETY INSTRUCTIONS FOR USE, CARE, CLEANING, AND DISPOSAL

⚠ WARNING

To reduce the risk of fire, electric shock, or injury to persons when using this appliance, follow basic precautions, including the following:

- **Unplug the washer before cleaning** to avoid the risk of electric shock.
- **Never use harsh chemicals, abrasive cleaners, or solvents to clean the washer.** They will damage the finish.
- **Do not put oily or greasy rags or clothing on top of the washer.** These substances give off vapors that could ignite the materials.
- **Do not wash items that are soiled with vegetable or cooking oil.** These items may contain some oil after laundering. Due to the remaining oil, the fabric may smoke or catch fire by itself.
- **Disconnect this appliance from the power supply before attempting any user maintenance. Turning the controls to the OFF position does not disconnect this appliance from the power supply.** Failure to follow this warning can cause serious injury, fire, electric shock, or death.
- **Do not combine laundry products for use in one load unless specified on the label.**
- **Do not mix chlorine bleach with ammonia or acids such as vinegar. Follow package directions when using laundry products.** Incorrect usage can produce poisonous gas, resulting in serious injury or death.
- **Do not reach into the washer while parts are moving. Before loading, unloading, or adding items, press the START/PAUSE button and allow the drum to coast to a complete stop before reaching inside.** Failure to follow this warning can cause serious injury, fire, electric shock, or death.
- **Do not allow children to play on or in the washer. Close supervision of children is necessary when the washer is used near children. As children grow, teach them the proper, safe use of all appliances.** Failure to comply with these warnings could result in serious injury to persons or death.
- **Destroy the carton, plastic bag, and other packing materials after the washer is unpacked. Children might use them for play. Cartons covered with rugs, bedspreads, or plastic sheets can become airtight chambers.** Failure to comply with these warnings could result in serious injury to persons or death.
- **Keep laundry products out of children's reach. To prevent injury to persons, observe all warnings on product labels.** Failure to comply with these warnings could result in serious injury to persons or death.
- **Remove the door to the washing compartment to avoid the danger of children or small animals getting trapped inside before your washer is removed from service or discarded.** Failure to do so can result in serious injury to persons or death.

SAVE THESE INSTRUCTIONS

TABLE OF CONTENTS

2 PRODUCT FEATURES

3 IMPORTANT SAFETY INSTRUCTIONS

- 3 BASIC SAFETY PRECAUTIONS
- 4 GROUNDING INSTRUCTIONS
- 5 SAFETY INSTRUCTIONS FOR INSTALLATION
- 6 SAFETY INSTRUCTIONS FOR USE, CARE, CLEANING, AND DISPOSAL

8 PARTS AND ACCESSORIES

- 8 Parts
- 8 Accessories

9 CONTROL PANEL FEATURES

- 9 Coin / Card type
- 10 OPL type

12 INSTALLATION INSTRUCTIONS

- 12 Checking and choosing the proper location
- 13 Unpacking and removing shipping bolts
- 14 Connecting the water lines
- 15 Connecting the drain line
- 16 Leveling the washing machine

17 PREPARATION

- 17 Precautions for fabric care before wash cycle
- 18 Fabric Care Labels
- 18 Sorting laundry
- 19 Using detergent/fabric softener
 - 19 - Recommended detergent
 - 19 - About the dispenser
- 20 - Loading the dispenser

21 OPERATING YOUR WASHER

22 PROGRAMMING MODE

- 23 Card/Coin type
- 24 OPL type
- 25 Programming mode - Setup Mode
 - 25 - 1. How to change regular price.
 - 26 - 2. How to change regular delicates price.
 - 27 - 3. How to change regular warm & cold price
 - 28 - 4. How to change regular hot price
 - 29 - 5. How to change special price
 - 30 - 6. How to change special delicates price
 - 31 - 7. How to change special warm & cold price
 - 32 - 8. How to change special hot price
 - 33 - 9. How to change add super wash price

- 34 - 10. How to change add super wash type
- 35 - 11. How to enter the **FERR**
- 36 - 11-1. Special price day setup
- 37 - 11-2. Non-stop rinse
- 38 - 11-3. Add super wash setup
- 39 - 11-4. Vend type setup - card type or coin type setup
- 40 - 11-5. Pre-wash set up
- 41 - 11-6. Twin spray set up
- 42 - 12. How to enter the special price day
 - 43 - 12-1. How to change to Sunday
- 44 - 13. Special price beginning time setup
- 45 - 14. Special price ending time setup
- 46 - 15. Washing time set up
- 47 - 16. Rinsing times per cycle
- 48 - 17. Rinsing time setup
- 49 - 18. Top spin speed - final spin time depends on RPM
 - 50 - 19. Value of coin 1
 - 51 - 20. Value of coin 2
- 52 - 21. Penny increment pricing offset
- 53 - 22. How to change the water level
- 54 - 23. Beep volume
- 55 - 24. Time to keep the coin (Use only for coin type)
- 56 - 25. How to enter the **E4PE**
- 57 Programming Mode - Test mode
 - 57 - 1. **L9C1**
 - 58 - 2. Factory reset - **EEPL**
 - 59 - 3. Time set up
 - 60 - 4. Courtesy cycle
 - 61 - 5. Cycle Kill
 - 62 - 6. Password - **PASS**
 - 63 - 7. Tub clean - **ECL**
- 64 Programming Mode - Collect mode
- 65 Collect Mode Data lists

66 MAINTENANCE

- 66 Care after wash
 - 66 - Storing the Washer
 - 66 - Cleaning the Dispenser
 - 67 - Cleaning the water inlet filters
 - 68 - Cleaning the drain pump filter
 - 69 - Cleaning the door seal
 - 69 - Clean the drum, TUB CLEAN

70 ERROR MODE

71 POWER FAIL RECOVERY

71 DEFAULT WASHER SETTINGS

71 SPECIFICATIONS

PARTS AND ACCESSORIES

Parts

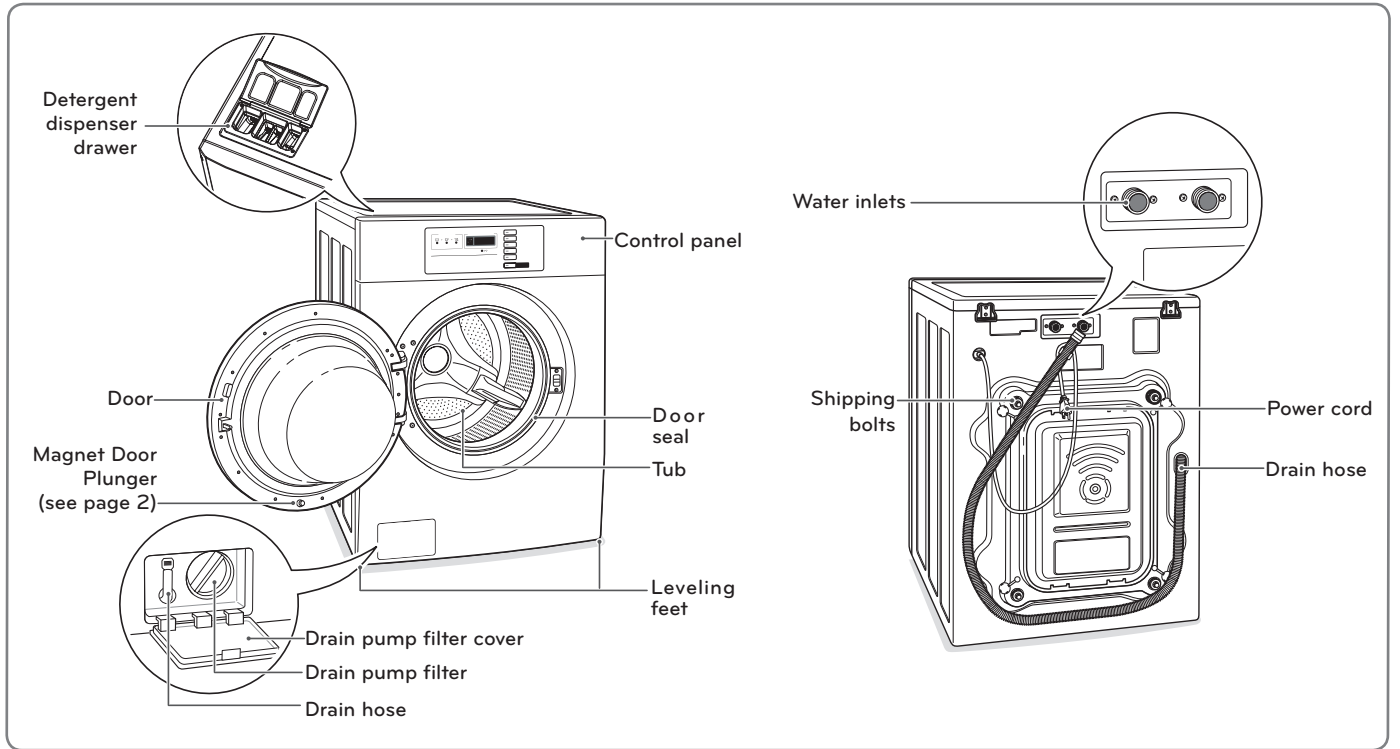

Accessories

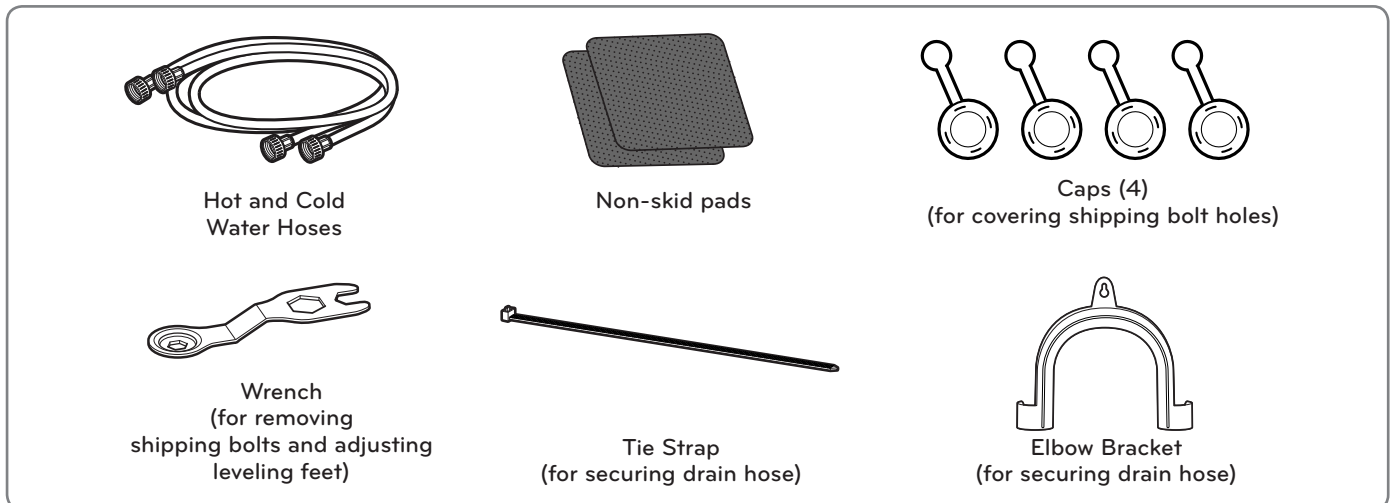

CONTROL PANEL FEATURES

Coin type (GCWP1069QS / GCWP1069QS2)

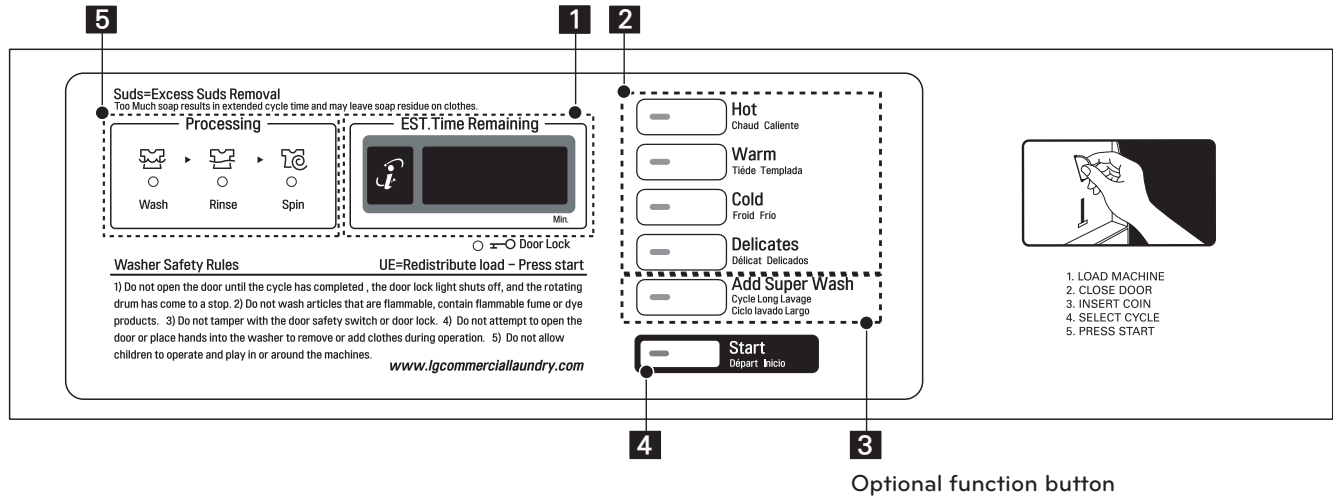

Card type (GCWP1069CS / GCWP1069CS2)

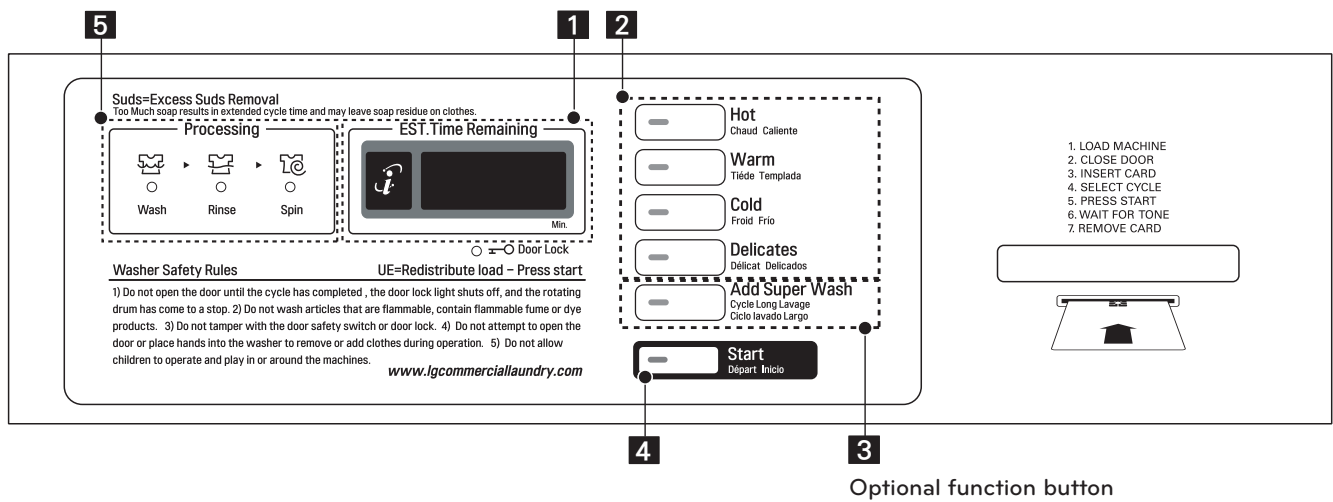

1. Display LED
2. Cycle button
3. Optional cycle button

4. Start button
5. Status LED

OPL type (GCWP1069LS / GCWP1069LS2)

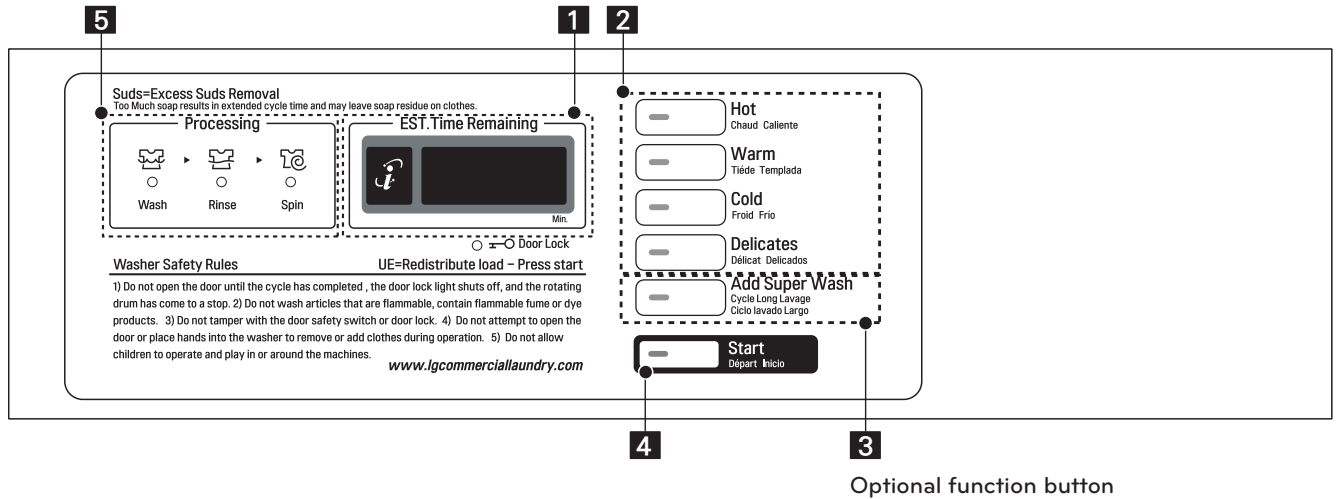

- 1. Display LED
- 2. Cycle button
- 3. Optional cycle button

- 4. Start button
- 5. Status LED

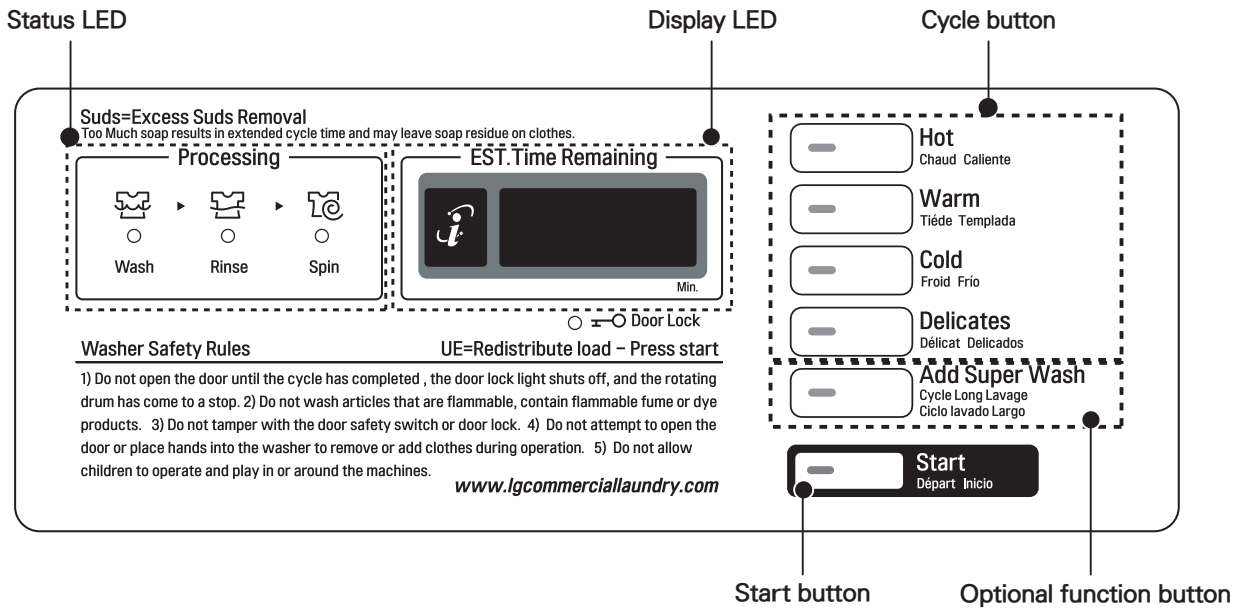

Display LED

The display shows the vend price and remaining time and programming options. Error codes are also displayed here.



Cycle button

Press the CYCLE button to select the desired cycle based on laundry types and conditions.

Hot

Use for hot washing for heavy fabrics, such as white clothes, table linens, and heavily soiled clothes.

Warm

Use for warm washing for heavy fabrics, such as jeans, corduroys, or work clothes.

Cold

Use for cold washing for sturdy fabrics, such as casual work.

Delicates

Use for cold washing for synthetic fabrics, such as washable knit fabric and no-iron finishes.

Optional function button

Wash time or rinse cycle can be added when additional coin is inserted or a valid cash card is entered.

Start button

The START LED flashes when the full vend price has been satisfied and the cycle has been chosen.

Status LED

LED	Description
	LED flashes whenever the washing cycle is in operation.
	LED flashes whenever the Rinsing cycle is in operation.
	LED flashes whenever the Spining cycle is in operation.
	LED flashes whenever the door lock is activated.

INSTALLATION INSTRUCTIONS

Checking and choosing the proper location

Install the washing machine on a solid floor that is strong and rigid enough to support the weight of the washing machine, even when fully loaded, without flexing or bouncing. If the floor has too much flex, you may need to reinforce it to make it more rigid. If the floor is not solid, it may cause severe vibration and noise.

- 1 Clean the floor before installation.
 - Make sure to select solid and smooth ground.
- 2 Two or more people are needed for moving and unpacking the washing machine.
- 3 Allow for sufficient space between the walls and the washing machine for installation.

Space requirements

You must allow sufficient space for water lines, the drain line, and airflow.

NOTE

- Be sure to allow for wall, door, or floor moldings that may increase the required clearances.

Installing on a floor

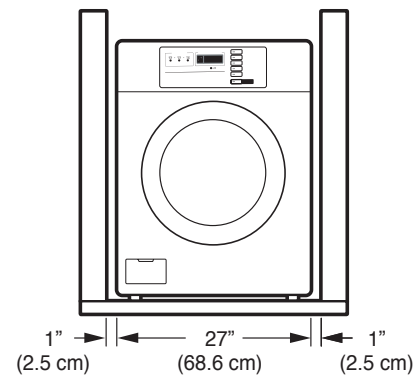
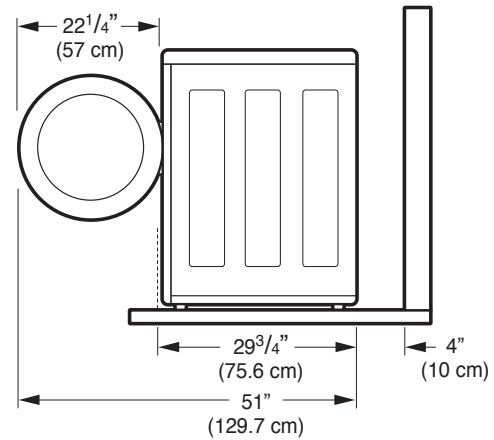

NOTE

- The floor must be strong and rigid enough to support the weight of the washer, when fully loaded, without flexing or bouncing. If your floor has too much flex, you may need to reinforce it to make it more rigid. A floor that is adequate for a top-loading washer may not be rigid enough for a front loading washer, due to the difference in the spin speed and direction. If the floor is not solid, your washer may vibrate and you may hear and feel the vibration throughout your house.
- Before installing the washer, make sure the floor is clean, dry and free of dust, dirt, water and oils so the washer feet can not slide easily. Leveling feet that can move or slide on the floor can contribute to excess vibration and noise due to poor contact with the floor.

Unpacking and removing shipping bolts

When removing the washer from the carton base, be sure to remove the foam drum support in the middle of the carton base.

If you must lay the washer down to remove the base packaging materials, always lay it carefully on its side. **DO NOT** lay the washer on its front or back.

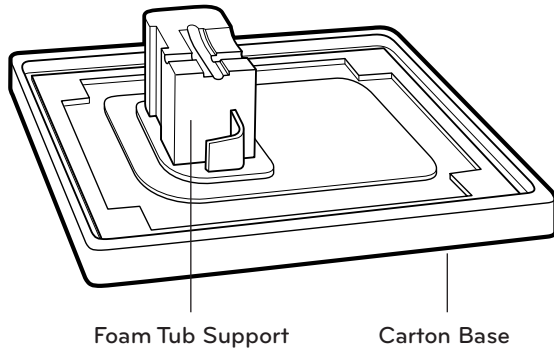

- 1 Remove the bottom two shipping bolts with the wrench (included) to fully loosen all four shipping bolts by turning them counterclockwise and then pulling them out.

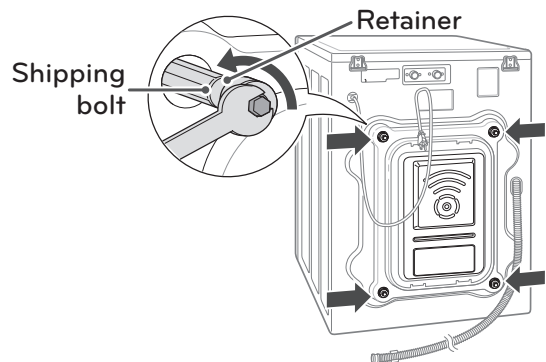

- 2 Locate the four hole caps included in the accessory pack and install them in the shipping bolt holes.

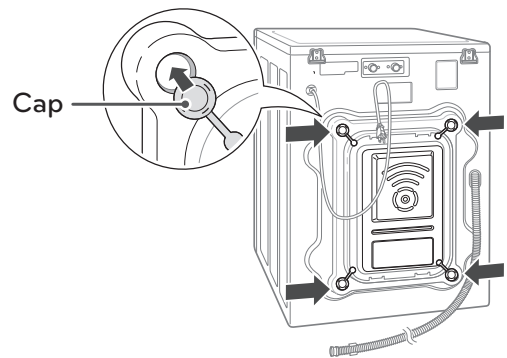

NOTE

- Save the bolt assemblies for future use. To prevent damage to internal components, **DO NOT** transport the washer without reinstalling the shipping bolts.
- Failure to remove shipping bolts and retainers may cause severe vibration and noise, which can lead to permanent damage to the washer. The cord is secured to the back of the washer with a shipping bolt to help prevent operation with shipping bolts in place.

Connecting the water lines

- 1 Check the rubber seals on both sides of the hose.
 - Insert a rubber seal into the threaded fittings on each hose to prevent leaking.

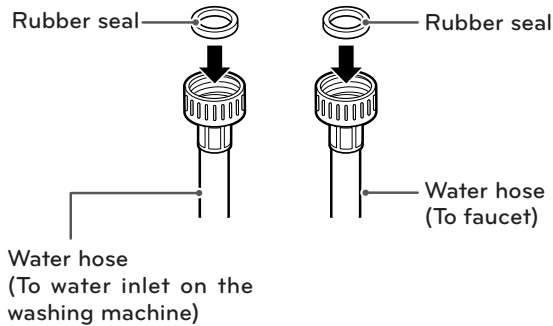

- 2 Connect the water supply hoses to the HOT and COLD water faucets tightly by hand and then tighten another 2/3 turn with pliers.
 - Connect the blue hose to a cold water faucet and the red hose to a hot water faucet.

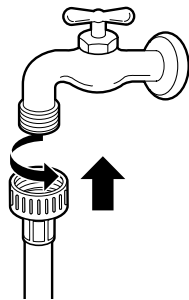

⚠ WARNING

- Do not overtighten. Damage to the coupling can result.

- 3 After connecting inlet hose to water faucets, turn on the water faucets to flush out foreign substances (dirt, sand, sawdust) in the water lines. Let water drain into a bucket, and check the water temperature.

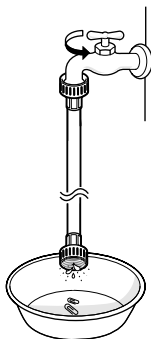

- 4 Connect the hoses to the water inlets tightly by hand and then tighten another 2/3 turn with pliers.
 - Connect the blue hose to the cold water inlet and the red hose to the hot water inlet.

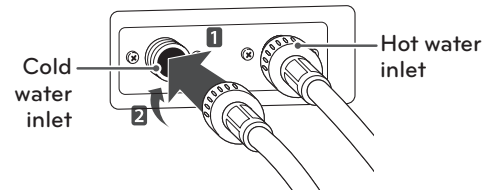

⚠ WARNING

- Do not overtighten the hoses. Overtightening can damage the valves resulting in leaking and property damage.

- 5 Check for leaks by turning on the faucets.
 - If water leaks, check steps 1 to 4 again.

ⓘ NOTE

- For your safety, and for extended product life, use only authorized components. The manufacturer is not responsible for product malfunction or accidents caused by the use of separately purchased unauthorized parts.
- Use new hoses when you install the washing machine. Do not reuse old hoses. Use only the inlet hoses provided with the washer. LG does not recommend the use of aftermarket hoses.
- Periodically check the hoses for cracks, leaks and wear, and replace the hoses every 5 years.
- Do not stretch the water hoses intentionally, and make sure that they are not crushed by other objects.
- Water supply pressure must be between 14.5 PSI and 116 PSI (100~800 kPa). If the water supply pressure is more than 116 PSI, a pressure reducing valve must be installed.
- To provide optimum washing performance the hot water temperature should be set at 120-135°F (48-57°C) and the cold at 60°F (15°C).

Connecting the drain line

Secure the drain hose in place to prevent moving and leaking.

NOTE

- The drain hose should be properly secured. Failure to properly secure the drain hose can result in flooding and malfunction.
- Total height of the house end should not exceed 96 inches (244.8 cm) from the bottom of the washer.
- The drain must be installed in accordance with any applicable local codes and regulations.
- Make sure that the water lines are not stretched, pinched, crushed, or kinked.

Using a standpipe

- 1 Clip the end of the hose into the elbow bracket.
 - Connect the elbow bracket within 4 inches (10 cm) from the end of the drain hose. If the drain hose is extended more than 4 inches (10 cm) beyond the end of the elbow bracket, mold or microorganisms could spread to the inside of the washer.

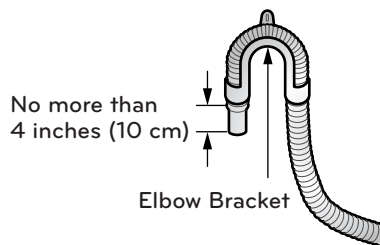

- 2 Insert the end of the drain hose into the standpipe.

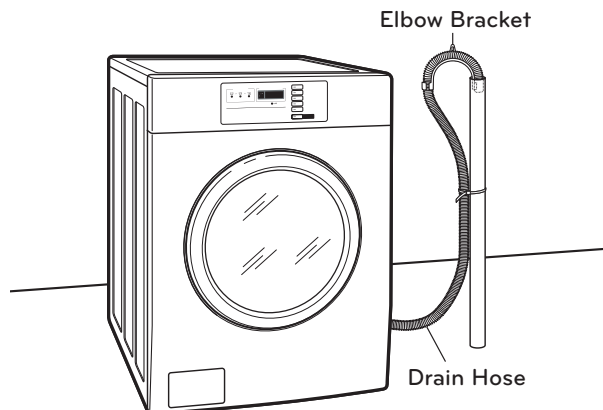

- 3 Use a tie strap to secure the drain hose in place.

Using a laundry tub

- 1 Clip the end of the hose into the elbow bracket.
 - Connect the elbow bracket within 4 inches (10 cm) from the end of the drain hose. If the drain hose is extended more than 4 inches (10 cm) beyond the end of the elbow bracket, mold, or microorganisms could spread to the inside of the washer.

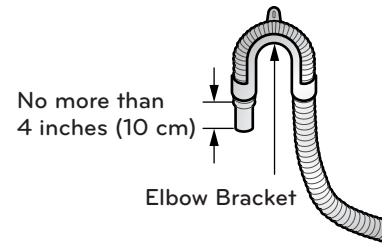

- 2 Hang the end of the drain hose over the side of the laundry tub.

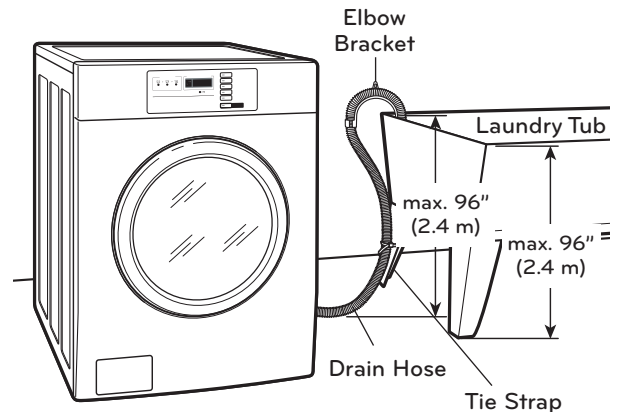

- 3 Use a tie strap to secure the drain hose in place.

Leveling the washing machine

The washer tub of your new washing machine spins at very high speeds. To minimize vibration, noise, and unwanted movement, the floor must be perfectly level and solid.

1 Check the washing machine's level.

- Check the precise level by rocking the top edges of the washing machine or placing a level on the washing machine. The slope beneath the washing machine must not exceed 1°, and all four leveling feet must rest firmly on the floor.

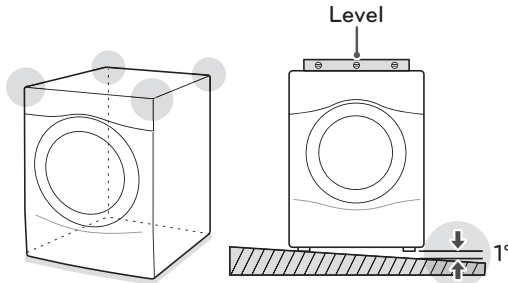

2 Turn the lower leveling feet clockwise to level the washing machine.

- Turning the lower leveling feet clockwise raises the washing machine.

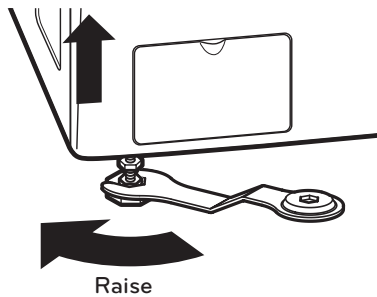

3 Turn the locknuts counterclockwise and tighten them when the washing machine is level.

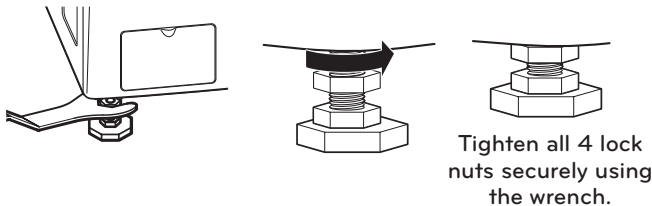

- 4 Check the washing machine's level again.
 - Push or rock the top edges of the washing machine gently to make sure that the washing machine does not rock.
 - If the washing machine rocks, repeat steps 1 to 3.

⚠ WARNING

- Using the washing machine without leveling, it may result in malfunction caused by the production of excess vibration and noise.
- **Use the leveling feet only when you level the washing machine.** If you raise the leveling feet unnecessarily, it may cause abnormal vibration of the washing machine.

Using non-skid pads (optional)

If you install the washing machine on a slippery surface, it may move because of excessive vibration. Incorrect leveling may cause malfunction through noise and vibration. In the event of this, lay the non-skid pads under the leveling feet and adjust the level.

- 1 Clean the floor to attach the non-skid pads.
 - Use a dry rag to remove and clean foreign objects or moisture. If moisture remains, the non-skid pads may slip.
- 2 Adjust the level after placing the washing machine in the installation area.
- 3 Place the adhesive side of the non-skid pad on the floor.
 - It is most effective to install the non-skid pads under the front legs. If it is hard to place the pads under the front legs, place them under the back legs.

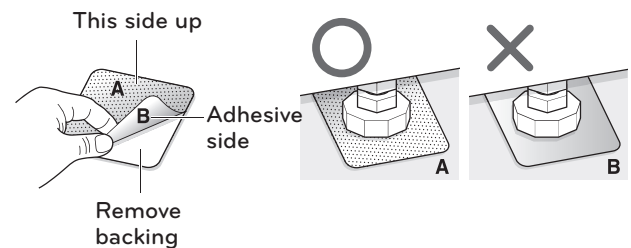

- 4 Check the washing machine's level again.
 - Push or rock the top edges of the washing machine gently to make sure that the washing machine does not rock. If the washing machine rocks, level the washing machine again.

PREPARATION











Precautions for fabric care before wash cycle

Read and observe the following to prevent shrinkage or damage to clothes.

- ◆ Check all pockets to make sure that they are empty.
 - Items such as clips, matches, pens, coins, and keys can damage both your washer and your clothes.
- ◆ Close zippers, hooks, and drawstrings to prevent these items from snagging or tangling on other clothes.
- ◆ Pretreat heavily stained areas before washing.
 - Doing so will produce clean, stain-free results.
- ◆ Combine large and small items in a load. Load large items first.
- ◆ Large items should not be more than half of the total washload.
- ◆ The washer can be fully loaded, but the drum should not be tightly packed with items.
 - The door of the washer should close easily.
- ◆ Do not wash single items, except for bulky items such as blankets. Make sure to wash laundry in similar types of loads.
 - Washing a single small item may result in the tub becoming unbalanced, vibrating, making a noise.
- ◆ Do not wash waterproof clothes.
 - This may cause abnormal vibration or may cause the load to bounce, which could damage the tub.
- ◆ Check if there are any other foreign objects in the door seal and take extra care that clothes do not get caught there.
 - Foreign objects in the door seal may stain clothes, and water may leak if clothes get caught in the door seal.
- ◆ Wash underwear or small, light items in a laundry net.
 - Small, light items may get caught in the door seal, and a brassiere hook may damage other items or the tub.
- ◆ Brush heavy soil, dust, or hair off fabrics before washing.
 - Laundry may not wash clean if there is dirt or sand on the fabrics, or they may be damaged due to particles rubbing against sheer fabrics.
- ◆ Wash blankets individually.
 - Washing more than one blanket together may produce unclear results due to tangling or an unbalanced load.
- ◆ Always separate fabrics according to their colors and wash them separately to prevent colors from running.
 - Fabrics may damage or become stained due to fabric dyes running or due to foreign objects transferring from one fabric to another.

Fabric care labels

Most articles of clothing feature fabric care labels that include instructions for proper care.

Category	Label	Directions
 Washing		Hand Wash
		Machine Wash, Normal Cycle
		Use Permanent Press/Wrinkle Resistant washing machine setting (which has a cool down or cold spray before the reduced spin)
		Use Gentle/Delicate washing machine setting (slow agitation and/ or reduced wash time).
		Do Not Wash
		Do Not Wring
Water Temperature	...	Hot
	..	Warm
	.	Cold/Cool
 Bleach symbols		Any Bleach (When Needed)
		Only Non-Chlorine Bleach (When Needed)
		Do Not Bleach

Sorting laundry

It is recommended that you sort laundry into similar loads that are washable in the same cycle.

Refer to the following chart for sorting clothes

Colors	Whites / Lights / Darks
Soil	Heavy / Normal / Light
Fabric	Delicates / Easy Care / Sturdy Cottons
Lint	Lint Producers / Lint Collectors

Using detergent/fabric softener

Recommended detergent

Make sure to use HE (High-Efficiency) detergent for front-loading washing machines. HE detergents dissolve more efficiently and produce fewer suds to ensure efficient washing and rinsing. Use the correct amount of detergent as indicated on the label of the detergent packaging.



Designed specially to use only
HE (High-Efficiency) detergent

! NOTE

- Only use HE detergents, since using a regular detergent will produce excessive suds.
- HE detergents produce fewer suds, dissolve more efficiently to improve washing and rinsing performance, and help to keep the interior of your washer clean.
- Use less detergent for soft water.
- Wipe up any spills immediately, as liquids could damage the finish and the control panel of the washing machine.
- Using too much detergent can cause a build-up in the tub resulting in unsatisfactory performance and machine malfunction.
- If you use a detergent that does not dissolve easily or a detergent with high viscosity, it will leave a residue on the tub, which may not rinse properly.

About the dispenser

The automatic dispenser consists of three compartments which hold:

- Liquid chlorine bleach.
- Liquid fabric softener.
- Liquid and powdered detergent and color-safe bleach for main wash.

All laundry products can be added at once in their respective dispenser compartments. They will be dispensed at the appropriate time for the most effective cleaning.

After adding the laundry products to the dispenser, close the dispenser cover.

To add detergent, bleach, and fabric softener to the automatic dispenser:

1. Open the dispenser cover.
2. Load the laundry products into the appropriate compartments.
3. Slowly close the dispenser cover to avoid early dispensing of the laundry products.

! NOTE

- It is normal for a small amount of water to remain in the dispenser compartments at the end of the cycle.

Loading the dispenser

Main Wash Detergent Compartment

This compartment holds laundry detergent for the main wash cycle, which is added to the load at the beginning of the cycle. Always use HE (High-Efficiency) detergent with your washing machine.

Follow the detergent manufacturer's instructions with respect to the amount of detergent to use, and never use more than the recommended amount. Using too much detergent can result in detergent buildup in clothing and the washer. Either powdered or liquid detergent may be used.

! NOTE

- Liquid or powdered color-safe bleach may be added to the main wash compartment with detergent of the same type.



Designed specially to use only HE (High-Efficiency) detergent

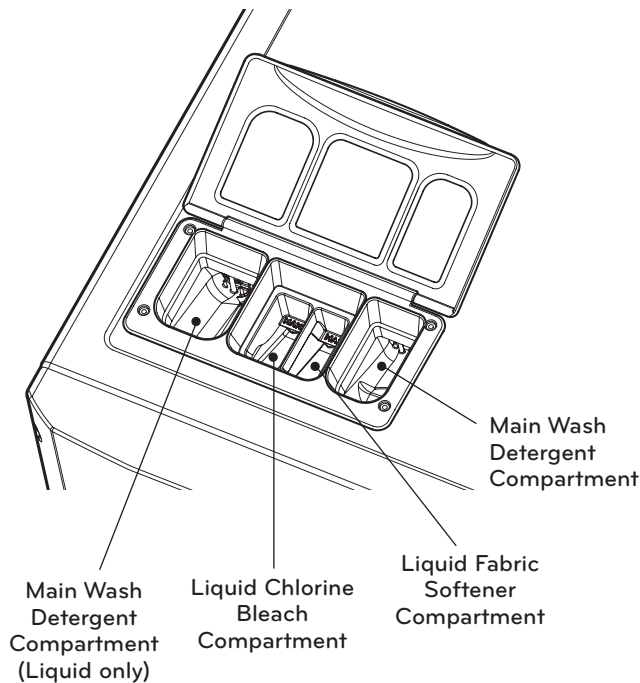

Liquid Bleach Compartment

This compartment holds liquid chlorine bleach, which will be dispensed automatically at the proper time during the wash cycle.

! NOTE

- Do not add powdered or liquid color-safe bleach to this compartment.
- Always follow the manufacturer's recommendations when adding bleach. Do not exceed the maximum fill line. Using too much bleach can damage fabrics.
- Never pour undiluted liquid chlorine bleach directly onto the load or into the drum. Fabric damage can occur.

Fabric Softener Compartment

This compartment holds liquid fabric softener, which will be automatically dispensed during the final rinse cycle.

! NOTE

- Always follow the manufacturer's recommendations when adding fabric softener. Do not exceed the maximum fill line. Using too much fabric softener may result in stained clothes.
- Dilute concentrated fabric softeners with warm water. Do not exceed the maximum fill line.
- Never pour fabric softener directly onto the load or into the drum.

OPERATING YOUR WASHER

1. Ready mode

1) Coin / Card type

- The cycle LEDs flash at the same time, when the price of cycles are equal.

2) OPL type

- The cycle LEDs is lit at the same time, and displayed PUSH.

2. Insert card/coin (not for OPL type)

Insert a cash card that has a sufficient balance.
The card balance should be more than the programmed vend price for a selected cycle.

! NOTE

- When the card balance is not enough, machine displays the card balance for 5 seconds and then displays **6888** message repetitively
- Insert a sufficient amount of change that is more than the programmed vend price for the selected cycle.

! NOTE

- The machine will not start until sufficient coins are inserted.

3. Select the cycle

Press the desired button and press the Start button.
The display LED will show the remaining time and the selected cycle starts.

- Select cycles designed for different types of fabric and soil levels.

CYCLE	Fabric type	Wash/Rinse Temp.
Hot	Cotton, linen, towels, shirts, sheets	Hot / Cold
Warm	Cotton, mixed loads, work clothes, jeans, shirts	Warm / Cold
Cold	Cotton, dress shirts, pants, wrinkle-free clothing, cotton/poly blend clothing, tablecloths	Cold / Cold
Delicates	Dress shirts, blouses, nylons, sheer or lacey garments	Cold / Cold

4. Add super wash

Wash time or rinse cycle can be added when additional coin is inserted or a valid cash card is entered.

5. Change course

You cannot change the cycle while the machine is running.

6 . Cycle finish

The machine stops and LED display shows **8888** with beeper sound.

- * Do not work any button and stop the washer (When the washer is operating) or (when a cycle is in progress)

! WARNING

- To reduce the risk of fire, electric shock, or injury to persons, **read the IMPORTANT SAFETY INSTRUCTIONS before operating this appliance.**

PROGRAMMING MODE

: You can check machine information or change setting on Program setup, Collect Information Data, Diagnostic Test.
There are two methods that you can enter programming mode.

How to enter Programming mode

You can enter programming mode only for Idle state and pause state.

- Card Type

- 1) Insert service card.
- 2) Display will show **L9C1**.

- Coin Type

- 1) Disassemble upper coin box key.
- 2) Take out the coin drop from the coin box.
- 3) Turn on/off the toggle switch at the back of the coin box.
- 4) Display will show **L9C1**.

- OPL Type

- 1) Push the Hot & Cold button at the same time.
- 2) Push the Warm button 3 times.
- 3) Push the Start button.
- 4) Display will show **L9C1**.

How to use button

You can change Washer vend price, cycle time and Cycle parameters, etc.

Press Button	Description
Hot	Move to upper level or Comes back to Idle State
Warm	Move to the mode in the same level (+)
Cold	Move to the modes in the same level (-)
Start	Enter the selected mode

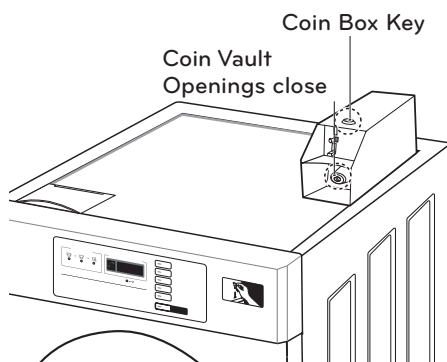

- coin type -

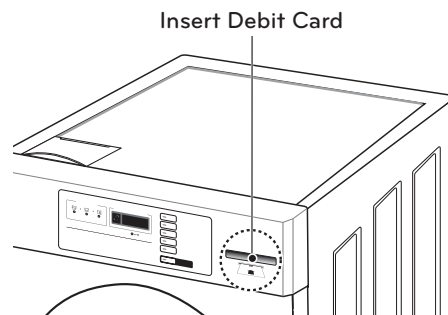

- card type -

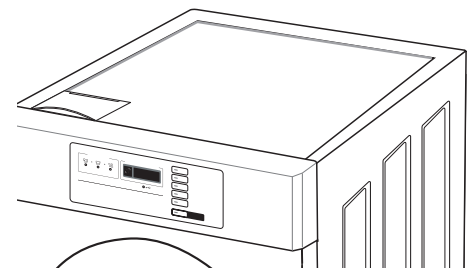

- OPL type -

NOTE

- If you turn on the power without connecting meter case for the first time, the machine display **L9C1**.
- When the machine is shipped from the factory, **it is set in the coin type**. You can change Card/Coin type by button. (For more information refer to SETUP mode.)
- The machine will display PUSH for OPL type

Card / Coin type

Algorithm flow chart shows how to control the programming mode.

Before program set, check the structure of the programming mode.

1. Turn on/off toggle switch or Insert service card, for entering set up mode.
2. Press Hot button to move to the upper level.
3. Press Warm (+) or Cold (-) button if you want to be at the same level.
4. Press Start button to enter the details of Set up or Diagnostic Tests.

SEUP is to set price value, time value, vend type, etc.

EESE consists of line test, reset, free cycle, and kill cycle.

EEEE is to collect the usage data.

Structure of Programming mode

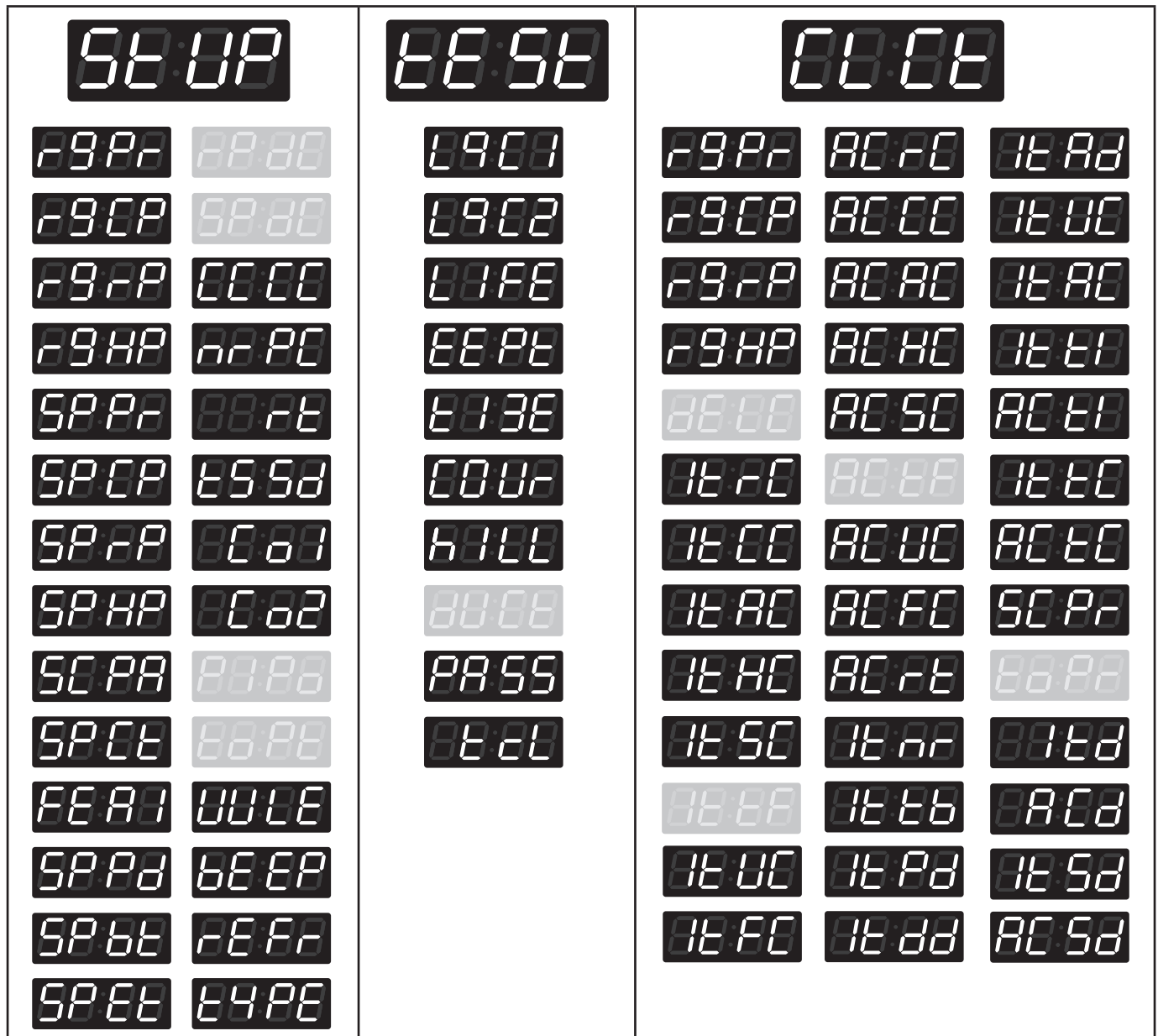

NOTE

- Do not use **U902**, **U1FE**.
- It is used only in inspecting the machine.

OPL type

Algorithm flow chart shows how to control the programming mode.

Before program set, check the structure of the programming mode.

The method of entering set up mode.

- 1) Push the Hot & Cold button at the same time.
- 2) Push the Warm button 3 times.
- 3) Push the Start button.
- 4) Display will show **L900**.

SEUP is to set price value, time value, vend type, etc.

EESE consists of line test, reset, free cycle, and kill cycle.

ELCE is to collect the usage data.

Structure of Programming mode

SEUP	EESE	ELCE
SPPA SPBB	L900	SPPA ACAC TEAD
SPCP SPDB	L902	SPCP ACCC TEUC
SPAP CCCC	U1FE	SPAP ACAC TEAC
SPHP AAPE	EEPE	SPHP ACAC TEAI
SPPA BBPE	BBBE	BBBB ACSC ACTI
SPCP ESSE	CCCP	TEAC ACAA TECE
SPAP BBBB	KILL	TECC ACUC ACTC
SPHP BBBB	BBBE	TEAC ACFC SCPA
SPCP PPPP	PASS	TEAC ACAC BBPA
SPCE BBPE	TEEL	TESC TEAA BBTE
FEA1 UUUE		TEAA TEEB ACCA
SPPA BBEP		TEUC TEPA TESE
SPBB APAA		TEFC TEBB ACSA
SPBB LYPE		

NOTE

- Do not use **L902**, **U1FE**.
- It is used only in inspecting the machine.







Setup Mode **SE UP** (display)

You can change washer vend price, cycle time, and cycle parameters, etc.









Entering set up mode

- Coin type – Turn on/off toggle switch.
- Card type – Insert the service card.
- OPL type – 1) Push the Hot & Cold button at the same time.
2) Push the Warm button 3 times.
- Then, the washer displays **LQC1**.







1. How to change regular price.

	Button	Display
Entering set up mode. You will see LqC1 	Press the Hot button.	
	Press the Warm or the Cold button until SE UP appears in the display.	
	Press the Start button.	
	Press the Start button. Display previous regular price.	
	Press Warm(+) or Cold(-) button to set the regular price. (The vend price can be set from 0 to 9.95 in 5¢ increments.)	
	Press the Start button. The machine sets up the regular price, then advances to the next process automatically.	
	1. Continue to set up the next price. 2. Stop the change of setup value and go back to ready mode. <ul style="list-style-type: none"> • Coin type - Turn on/off toggle switch. • Card type - Pull the service card. • OPL type/Coin type - Push the Hot button twice 	







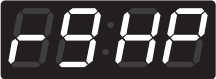

2. How to change regular delicates price.

	Button	Display
<p>Entering set up mode. You will see LqC1</p> 	<p>Press the Hot button.</p>	
	<p>Press the Warm or the Cold button until SE UP appears in the display.</p>	
	<p>Press the Start button.</p>	
	<p>Press the Warm or the Cold button until 29:22 appears in the display.</p>	
	<p>Press the Start button. Display previous regular cold price.</p>	
	<p>Press Warm(+) or Cold(-) button to set the regular cold price. (The vend price can be set from \$0.00 to \$9.95 in 5¢ increments.)</p>	
	<p>Press the Start button. The machine sets up the regular cold price, then advances to the next process automatically.</p>	
	<p>1. Continue to set up the next price. 2. Stop the change of setup value and go back to ready mode.</p> <ul style="list-style-type: none"> • Coin type - Turn on/off toggle switch. • Card type - Pull the service card. • OPL type - Push the Hot button twice. 	









3. How to change regular warm & cold price

	Button	Display
Entering set up mode. You will see LqC1 	Press the Hot button.	
	Press the Warm or the Cold button until SE UP appears in the display.	
	Press the Start button.	
	Press the Warm or the Cold button until 29.88 appears in the display.	
	Press the Start button. Display previous regular warm price.	
	Press Warm(+) or Cold(-) button to set the regular warm price. (The vend price can be set from \$0.00 to \$9.95 in 5¢ increments.)	
	Press the Start button. The machine sets up the regular warm price, then advances to the next process automatically.	
	1. Continue to set up the next price. 2. Stop the change of setup value and go back to ready mode. <ul style="list-style-type: none"> • Coin type - Turn on/off toggle switch. • Card type - Pull the service card. • OPL type - Push the Hot button twice. 	









4. How to change regular hot price

	Button	Display
Entering set up mode. You will see LqC1 	Press the Hot button.	
	Press the Warm or the Cold button until SE UP appears in the display.	
	Press the Start button.	
	Press the Warm or the Cold button until 29.99 appears in the display.	
	Press the Start button. Display previous regular hot price.	
	Press Warm(+) or Cold(-) button to set the regular hot price. (The vend price can be set from \$0.00 to \$9.95 in 5¢ increments.)	
	Press the Start button. The machine sets up the regular hot price, then advances to the next process automatically.	
	1. Continue to set up the next price. 2. Stop the change of setup value and go back to ready mode. <ul style="list-style-type: none"> • Coin type - Turn on/off toggle switch. • Card type - Pull the service card. • OPL type - Push the Hot button twice. 	









5. How to change special price

	Button	Display
Entering set up mode. You will see LqC1 	Press the Hot button.	
	Press the Warm or the Cold button until SE UP appears in the display.	
	Press the Start button.	
	Press the Warm or the Cold button until SPP appears in the display.	
	Press the Start button. Display previous special price.	
	Press Warm(+) or Cold(-) button to set a special price. (The vend price can be set from \$0.00 to \$9.95 in 5¢ increments.)	
	Press the Start button. The machine sets up the special price, then advances to the next process automatically.	
	1. Continue to set up the next price. 2. Stop the change of setup value and go back to ready mode. <ul style="list-style-type: none"> • Coin type - Turn on/off toggle switch. • Card type - Pull the service card. • OPL type - Push the Hot button twice. 	









6. How to change special delicates price

	Button	Display
Entering set up mode. You will see LqC1 	Press the Hot button.	
	Press the Warm or the Cold button until SEUP appears in the display.	
	Press the Start button.	
	Press the Warm or the Cold button until SPCP appears in the display.	
	Press the Start button. Display previous special cold price.	
	Press Warm(+) or Cold(-) button to set the special cold price. (The vend price can be set from \$0.00 to \$9.95 in 5¢ increments.)	
	Press the Start button. The machine sets up the special cold price, then advances to the next process automatically.	
	1. Continue to set up the next price. 2. Stop the change of setup value and go back to ready mode. <ul style="list-style-type: none"> • Coin type - Turn on/off toggle switch. • Card type - Pull the service card. • OPL type - Push the Hot button twice. 	









7. How to change special warm & cold price

	Button	Display
Entering set up mode. You will see LqC1 	Press the Hot button.	
	Press the Warm or the Cold button until SE UP appears in the display.	
	Press the Start button.	
	Press the Warm or the Cold button until SP P appears in the display.	
	Press the Start button. Display previous special warm price.	
	Press Warm(+) or Cold(-) button to set the special warm price. (The vend price can be set from \$0.00 to \$9.95 in 5¢ increments.)	
	Press the Start button. The machine sets up the special warm price, then advances to the next process automatically.	
	1. Continue to set up the next price. 2. Stop the change of setup value and go back to ready mode. <ul style="list-style-type: none"> • Coin type - Turn on/off toggle switch. • Card type - Pull the service card. • OPL type - Push the Hot button twice. 	













8. How to change special hot price

	Button	Display
Entering set up mode. You will see LqC1 	Press the Hot button.	
	Press the Warm or the Cold button until SE UP appears in the display.	
	Press the Start button.	
	Press the Warm or the Cold button until SP HP appears in the display.	
	Press the Start button. Display previous special hot price.	
	Press Warm(+) or Cold(-) button to set the special hot price. (The vend price can be set from \$0.00 to \$9.95 in 5¢ increments.)	
	Press the Start button. The machine sets up the special hot price, then advances to the next process automatically.	
	1. Continue to set up the next price. 2. Stop the change of setup value and go back to ready mode. <ul style="list-style-type: none"> • Coin type - Turn on/off toggle switch. • Card type - Pull the service card. • OPL type - Push the Hot button twice. 	



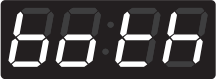

9. How to change add super wash price

	Button	Display
Entering set up mode. You will see LqC1 	Press the Hot button.	
	Press the Warm or the Cold button until SE UP appears in the display.	
	Press the Start button.	
	Press the Warm or the Cold button until SE PR appears in the display.	
	Press the Start button. Display previous add super wash price.	
	Press Warm(+) or Cold(-) button to set add super wash price. (The vend price can be set from \$0.00 to \$9.95 in 5¢ increments.)	
	Press the Start button. The machine sets up the add super wash price, then advances to the next process automatically.	
	1. Continue to set up the next mode. 2. Stop the change of setup value and go back to ready mode. <ul style="list-style-type: none"> • Coin type - Turn on/off toggle switch. • Card type - Pull the service card. • OPL type - Push the Hot button twice. 	

10. How to change add super wash type

	Button	Display
<p>Entering set up mode. You will see LqC1</p> 	<p>Press the Hot button.</p>	
	<p>Press the Warm or the Cold button until SE UP appears in the display.</p>	
	<p>Press the Start button.</p>	
	<p>Press the Warm or the Cold button until SP CE appears in the display.</p>	
	<p>Press the Start button. Display previous add super wash type.</p>	
<p>Press Warm or Cold button and then select the add super wash type you want.</p>  Wash time increase.  Both (Wash time increase and rinsing once more.)  Rinsing once more.		  
	<p>Press the Start button. The machine sets up the add super wash type, then advances to the next process automatically.</p>	
	<p>1. Continue to set up the next mode. 2. Stop the change of setup value and go back to ready mode.</p> <ul style="list-style-type: none"> • Coin type - Turn on/off toggle switch. • Card type - Pull the service card. • OPL type - Push the Hot button twice. 	

11. How to enter the **FEA1**

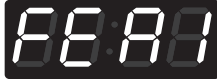
	Button	Display
Entering set up mode. You will see LqC1 	Press the Hot button.	
	Press the Warm or the Cold button until SE UP appears in the display.	
	Press the Start button.	
	Press the Warm or the Cold button until FEA1 appears in the display.	



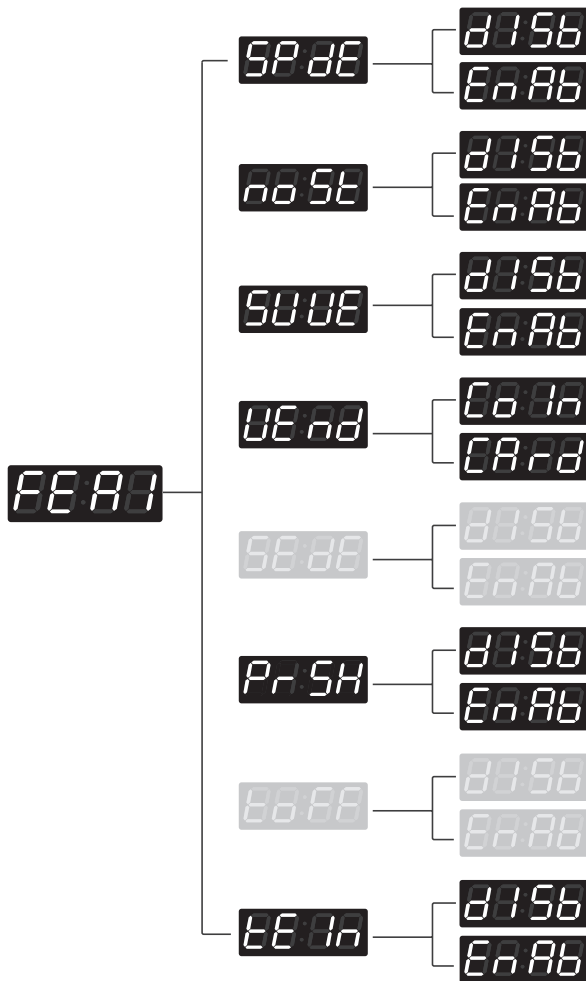







Structure of **FEA1**







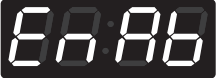







Content of **FEA1**

- SP DE** • Special price days apply or not
- no St** • Non-stop wash apply or not
- SU VE** • Add super wash apply or not
- WE nd** • Select vend type
- SE DE** • Sense dry apply or not (only for dryer)
- Pr SH** • Pre-wash apply or not
- EE In** • Top off apply or not (only for dryer)
- EE In** • Twin spray apply or not
- d15b** • Disable
- EN Ab** • Enable













11-1. Special price day setup

	Button	Display
Entering set up mode. You will see LqC1 	Press the Hot button.	
	Press the Warm or the Cold button until SE UP appears in the display.	
	Press the Start button.	
	Press the Warm or the Cold button until FEA1 appears in the display.	
	Press the Start button. Display SP:2E .	
Press the Start button. Press Warm or Cold button and then select DISB or ENAB .  Disable  Enable	One or the other will display.  	
	Press the Start button. The machine sets up the special price day, then advances to the next process automatically.	
1. Continue to set up the next mode. 2. Stop the change of setup value and go back to ready mode. <ul style="list-style-type: none"> • Coin type - Turn on/off toggle switch. • Card type - Pull the service card. • OPL type - Push the Hot button twice. 		











11-2. Non-stop rinse

	Button	Display
Entering set up mode. You will see LqC1 	Press the Hot button.	
	Press the Warm or the Cold button until SE UP appears in the display.	
	Press the Start button.	
	Press the Warm or the Cold button until FEA1 appears in the display.	
	Press the Start button. Display SP:2E .	
	Press the Warm or the Cold button until no SE appears in the display.	
Press the Start button. Press Warm or Cold button and then select DI:56 or EA:Ab .  Disable  Enable		One or the other will display.  
	Press the Start button. The machine sets up the add super wash application, then advances to the next process automatically.	
	1. Continue to set up the next mode. 2. Stop the change of setup value and go back to ready mode. <ul style="list-style-type: none"> • Coin type - Turn on/off toggle switch. • Card type - Pull the service card. • OPL type - Push the Hot button twice. 	

11-3. Add super wash setup

	Button	Display
<p>Entering set up mode. You will see LqC1</p> 	<p>Press the Hot button.</p>	
	<p>Press the Warm or the Cold button until SEUP appears in the display.</p>	
	<p>Press the Start button.</p>	
	<p>Press the Warm or the Cold button until FEA1 appears in the display.</p>	
	<p>Press the Start button. Display SP:2E.</p>	
	<p>Press the Warm or the Cold button until SUUE appears in the display.</p>	
<p>Press the Start button. Press Warm or Cold button and then select D156 or EAAb.</p>  <p>Disable</p>  <p>Enable</p>		<p>One or the other will display.</p>  
	<p>Press the Start button. The machine sets up the add super wash application, then advances to the next process automatically.</p>	
	<p>1. Continue to set up the next mode. 2. Stop the change of setup value and go back to ready mode.</p> <ul style="list-style-type: none"> • Coin type - Turn on/off toggle switch. • Card type - Pull the service card. • OPL type - Push the Hot button twice. 	













11-4. Vend type setup - card type or coin type setup

	Button	Display
Entering set up mode. You will see LqC1 	Press the Hot button.	
	Press the Warm or the Cold button until SE UP appears in the display.	
	Press the Start button.	
	Press the Warm or the Cold button until FEA1 appears in the display.	
	Press the Start button. Display SP:DE .	
	Press the Warm or the Cold button until UE:AD appears in the display.	
Press the Start button. Press Warm or Cold button and then select COIN or CARD .  Coin type  Card type		One or the other will display.  
	1. Continue to set up the next mode. 2. Stop the change of setup value and go back to ready mode. <ul style="list-style-type: none"> • Coin type - Turn on/off toggle switch. • Card type - Pull the service card. • OPL type - Push the Hot button twice. 	

NOTE

- After setting the Value to VEND, vend type is changed directly without power on/off **SE:DE** (Sense dry) is not available in washer













11-5. Pre-wash set up

	Button	Display
Entering set up mode. You will see LqC1 	Press the Hot button.	
	Press the Warm or the Cold button until SE UP appears in the display.	
	Press the Start button.	
	Press the Warm or the Cold button until FEA1 appears in the display.	
	Press the Start button. Display SP 2E .	
	Press the Warm or the Cold button until Pr SH appears in the display.	
Press the Start button. Press Warm or Cold button and then select DiSB or EAAb .  Disable  Enable		One or the other will display.  
	Press the Start button. The machine sets up the pre-wash, then advances to the next process automatically.	
	1. Continue to set up the next mode. 2. Stop the change of setup value and go back to ready mode. <ul style="list-style-type: none"> • Coin type - Turn on/off toggle switch. • Card type - Pull the service card. • OPL type - Push the Hot button twice. 	





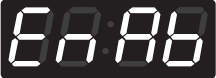

NOTE

- **LoFF** (top off) is not available in washer (Only for dryer)

11-6. Twin spray set up

	Button	Display
Entering set up mode. You will see LqC1 	Press the Hot button.	
	Press the Warm or the Cold button until SE UP appears in the display.	
	Press the Start button.	
	Press the Warm or the Cold button until FEA1 appears in the display.	
	Press the Start button. Display SP:2E .	
	Press the Warm or the Cold button until EE:1n appears in the display.	
Press the Start button. Press Warm or Cold button and then select D156 or EA86 .  Disable  Enable		One or the other will display.  
	Press the Start button. The machine sets up the pre-wash, then advances to the next process automatically.	
	1. Continue to set up the next mode. 2. Stop the change of setup value and go back to ready mode. <ul style="list-style-type: none"> • Coin type - Turn on/off toggle switch. • Card type - Pull the service card. • OPL type - Push the Hot button twice. 	







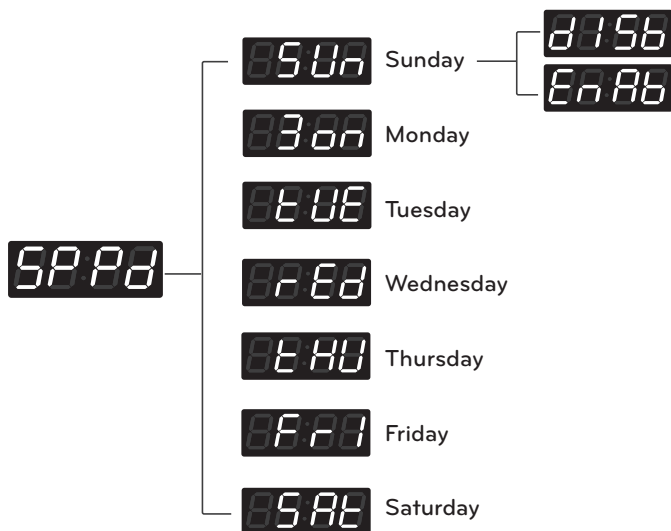



12. How to enter the special price day

	Button	Display
Entering set up mode. You will see LqC1 	Press the Hot button.	
	Press the Warm or the Cold button until SEUP appears in the display.	
	Press the Start button.	
	Press the Warm or the Cold button until SPPd appears in the display.	
	Press the Start button. Display SUn .	

Structure of **SPPd**









12-1. How to change to Sunday

	Button	Display
Entering set up mode. You will see LqC1 	Press the Hot button.	
	Press the Warm or the Cold button until SEUP appears in the display.	
	Press the Start button.	
	Press the Warm or the Cold button until SPPd appears in the display.	
	Press the Start button. Display SUn .	
	Press the Start button. Press Warm or Cold button and then select DISB or ENAB .  Disable  Enable	One or the other will display.  
	Press the Start button. The machine sets up the special price day (Sunday), then advances to the next process automatically.	
	1. Continue to set up the next mode. 2. Stop the change of setup value and go back to ready mode. <ul style="list-style-type: none"> • Coin type - Turn on/off toggle switch. • Card type - Pull the service card. • OPL type - Push the Hot button twice. 	



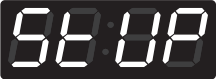



NOTE

- As explained on the previous page, similarly, other days can be set up by the same method.

13. Special price beginning time setup

	Button	Display
Entering set up mode. You will see LqC1 	Press the Hot button.	
	Press the Warm or the Cold button until SE UP appears in the display.	
	Press the Start button.	
	Press the Warm or the Cold button until SP 00 appears in the display.	
	Press the Start button. Display previous special price beginning time.	
	Press Warm(+) or Cold(-) button to select time between 0 and 23 .	
	Press the Start button. The machine sets up the special price beginning time, then advances to the next process automatically.	
	1. Continue to set up the next mode. 2. Stop the change of setup value and go back to ready mode. <ul style="list-style-type: none"> • Coin type - Turn on/off toggle switch. • Card type - Pull the service card. • OPL type - Push the Hot button twice. 	

14. Special price ending time setup

	Button	Display
Entering set up mode. You will see LqC1 	Press the Hot button.	
	Press the Warm or the Cold button until SE UP appears in the display.	
	Press the Start button.	
	Press the Warm or the Cold button until SPEE appears in the display.	
	Press the Start button. Display previous Special Price ending time.	
	Press Warm(+) or Cold(-) button to select time between 1 and 24 .	
	Press the Start button. The machine sets up the special price ending time, then advances to the next process automatically.	
	1. Continue to set up the next mode. 2. Stop the change of setup value and go back to ready mode. <ul style="list-style-type: none"> • Coin type - Turn on/off toggle switch. • Card type - Pull the service card. • OPL type - Push the Hot button twice. 	







NOTE

- **FP DL** (regular priced dryer cycle time) is not available in washer.
- **SP DL** (special priced dryer cycle time) is not available in washer.



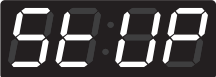



NOTE

- When setting up a special price period, the ending time must be later than the beginning time.







15. Washing time set up

	Button	Display
Entering set up mode. You will see LqC1 	Press the Hot button.	
	Press the Warm or the Cold button until SE UP appears in the display.	
	Press the Start button.	
	Press the Warm or the Cold button until 00:00 appears in the display.	
	Press the Start button. Display previous wash time.	
	Press Warm(+) or Cold(-) button to select wash time. (Maximum 15 minutes, Minimum 5 minutes.)	
	Press the Start button. The machine sets up the wash time, then advances to the next process automatically.	
	1. Continue to set up the next mode. 2. Stop the change of setup value and go back to ready mode. <ul style="list-style-type: none"> • Coin type – Turn on/off toggle switch. • Card type – Insert the service card. • OPL type – Push the Hot button twice. 	



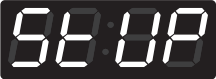



16. Rinsing times per cycle

	Button	Display
Entering set up mode. You will see LqC1 	Press the Hot button.	
	Press the Warm or the Cold button until SE UP appears in the display.	
	Press the Start button.	
	Press the Warm or the Cold button until nr PC appears in the display.	
	Press the Start button. Display previous rinsing times per cycle.	
	Press Warm(+) or Cold(-) button to select rinsing times per cycle. (Max 5, Min 1)	
	Press the Start button. The machine sets up the rinsing times per cycle, then advances to the next process automatically.	
	1. Continue to set up the next mode. 2. Stop the change of setup value and go back to ready mode. <ul style="list-style-type: none"> • Coin type – Turn on/off toggle switch. • Card type – Insert the service card. • OPL type – Push the Hot button twice. 	

17. Rinsing time setup

	Button	Display
Entering set up mode. You will see LqC1 	Press the Hot button.	
	Press the Warm or the Cold button until SE UP appears in the display.	
	Press the Start button.	
	Press the Warm or the Cold button until 00:00 appears in the display.	
	Press the Start button. Display previous rinsing time.	
	Press Warm(+) or Cold(-) button to select rinse cycle. (Max 15min, Min 8min)	
	Press the Start button. The machine sets up the rinsing time, then advances to the next process automatically.	
	1. Continue to set up the next mode. 2. Stop the change of setup value and go back to ready mode. <ul style="list-style-type: none"> • Coin type – Turn on/off toggle switch. • Card type – Insert the service card. • OPL type – Push the Hot button twice. 	

18. Top spin speed – final spin time depends on RPM







	Button	Display
Entering set up mode. You will see LqC1 	Press the Hot button.	
	Press the Warm or the Cold button until SE UP appears in the display.	
	Press the Start button.	
	Press the Warm or the Cold button until ES 58 appears in the display.	
	Press the Start button. Display previous top spin speed.	
	Press Warm(+) or Cold(-) button to select top spin speed. (0~3)	
	Press the Start button. The machine sets up the top spin speed, then advances to the next process automatically.	
	1. Continue to set up the next mode. 2. Stop the change of setup value and go back to ready mode. <ul style="list-style-type: none"> • Coin type – Turn on/off toggle switch. • Card type – Insert the service card. • OPL type – Push the Hot button twice. 	

NOTE



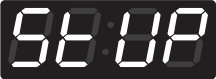



- Top spin speed

- 0 : 1150 rpm
- 1 : 1000 rpm
- 2 : 800 rpm
- 3 : 700 rpm

19. Value of coin 1

	Button	Display
Entering set up mode. You will see LqC1 	Press the Hot button.	
	Press the Warm or the Cold button until SETUP appears in the display.	
	Press the Start button.	
	Press the Warm or the Cold button until Co1 appears in the display.	
	Press the Start button. Display previous coin 1 value.	
	Press Warm(+) or Cold(-) button to select value of coin 1 (The value can be set from \$0.00 to \$9.95 in 25¢ increments.)	
	Press the Start button. The machine sets up the value of coin 1, then advances to the next process automatically.	
	1. Continue to set up the next price. 2. Stop the change of setup value and go back to ready mode. <ul style="list-style-type: none"> • Coin type - Turn on/off toggle switch. • Card type - Pull the service card. • OPL type - Push the Hot button twice. 	

20. Value of coin 2







	Button	Display
Entering set up mode. You will see LqC1 	Press the Hot button.	
	Press the Warm or the Cold button until SETUP appears in the display.	
	Press the Start button.	
	Press the Warm or the Cold button until CO2 appears in the display.	
	Press the Start button. Display previous Coin 2 value.	
	Press Warm(+) or Cold(-) button to select value of coin 2. (The value can be set from \$0.00 to \$9.95 in 5¢ increments.)	
	Press the Start button. The machine sets up the value of Coin 2, then advances to the next process automatically.	
	1. Continue to set up the next mode. 2. Stop the change of setup value and go back to ready mode. <ul style="list-style-type: none"> • Coin type - Turn on/off toggle switch. • Card type - Pull the service card. • OPL type - Push the Hot button twice. 	

NOTE

- Coin 2 is available for E-suds system

21. Penny increment pricing offset

This represents the cent increment price offset used when debit card is setup.

	Button	Display
<p>Entering set up mode. You will see LqC1</p> 	<p>Press the Hot button.</p>	
	<p>Press the Warm or the Cold button until SE UP appears in the display.</p>	
	<p>Press the Start button.</p>	
	<p>Press the Warm or the Cold button until PIPo appears in the display.</p>	
	<p>Press the Start button. Display previous penny increment pricing offset.</p>	
	<p>Press Warm(+) or Cold(-) button to select value of PIPo. (0~4)</p>	
	<p>Press the Start button. The machine sets up the value of PIPo, then advances to the next process automatically.</p>	
	<p>1. Continue to set up the next mode. 2. Stop the change of setup value and go back to ready mode.</p> <ul style="list-style-type: none"> • Coin type - Turn on/off toggle switch. • Card type - Pull the service card. • OPL type - Push the Hot button twice. 	









! NOTE

- Penny Increment Pricing Offset is available only in card type.
(It hasn't affected the coin type's price setting.)
- TOP** (top off time) is not available in washer.

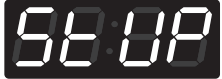
22. How to change the water level

You can change the water level by selecting two options.







1. Lo indicate water level 23.8 [KHz]
2. 3ldd indicate water level 23.5 [KHz]
2. HI indicate water level 23.0 [KHz]

	Button	Display
<p>Entering set up mode. You will see LqC1</p> 	<p>Press the Hot button.</p>	
	<p>Press the Warm or the Cold button until SE UP appears in the display.</p>	
	<p>Press the Start button.</p>	
	<p>Press the Warm or the Cold button until WULE appears in the display.</p>	
	<p>Press the Start button. Press Warm(+) or Cold(-) button and then select Lo or 3ldd or HI Lo 23.8 [KHz] 3ldd 23.5 [KHz] HI 23.0 [KHz]</p>	<p>One or the other will display.</p>   
	<p>Press the Start button. The machine sets up the value of water level, then advances to the next process automatically.</p>	
	<ol style="list-style-type: none"> 1. Continue to set up the next mode. 2. Stop the change of setup value and go back to ready mode. <ul style="list-style-type: none"> • Coin type – Turn on/off toggle switch. • Card type – Insert the service card. • OPL type – Push the Hot button twice. 	



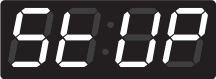



NOTE

- This function can be set only at the machine. It cannot be managed via the setup card.
(It is not applied in setup card.)





23. Beep volume

	Button	Display
Entering set up mode. You will see LqC1 	Press the Hot button.	
	Press the Warm or the Cold button until SE UP appears in the display.	
	Press the Start button.	
	Press the Warm or the Cold button until BE EP appears in the display.	
	Press the Start button. Display previous value.	
	Press Warm(+) or Cold(-) button to select High or Low or Off.	
	Press the Start button. The machine sets up the beep volume, then advances to the next process automatically.	
	1. Continue to set up the next mode. 2. Stop the change of setup value and go back to ready mode. <ul style="list-style-type: none"> • Coin type – Turn on/off toggle switch. • Card type – Insert the service card. • OPL type – Push the Hot button twice. 	

24. Time to keep the coin (Use only for coin type)

	Button	Display
Entering set up mode. You will see LqC1 	Press the Hot button.	
	Press the Warm or the Cold button until SE UP appears in the display.	
	Press the Start button.	
	Press the Warm or the Cold button until REFR appears in the display.	
	Press the Start button. Display previous value.	
	Press Warm(+) or Cold(-) button to select button to select time between 0 ~ 180.	
	Press the Start button. The machine sets up the time to keep the coin, then advances to the next process automatically.	
	1. Continue to set up the next mode. 2. Stop the change of setup value and go back to ready mode. <ul style="list-style-type: none"> • Coin type - Turn on/off toggle switch. • Card type - Pull the service card. • OPL type - Push the Hot button twice. 	



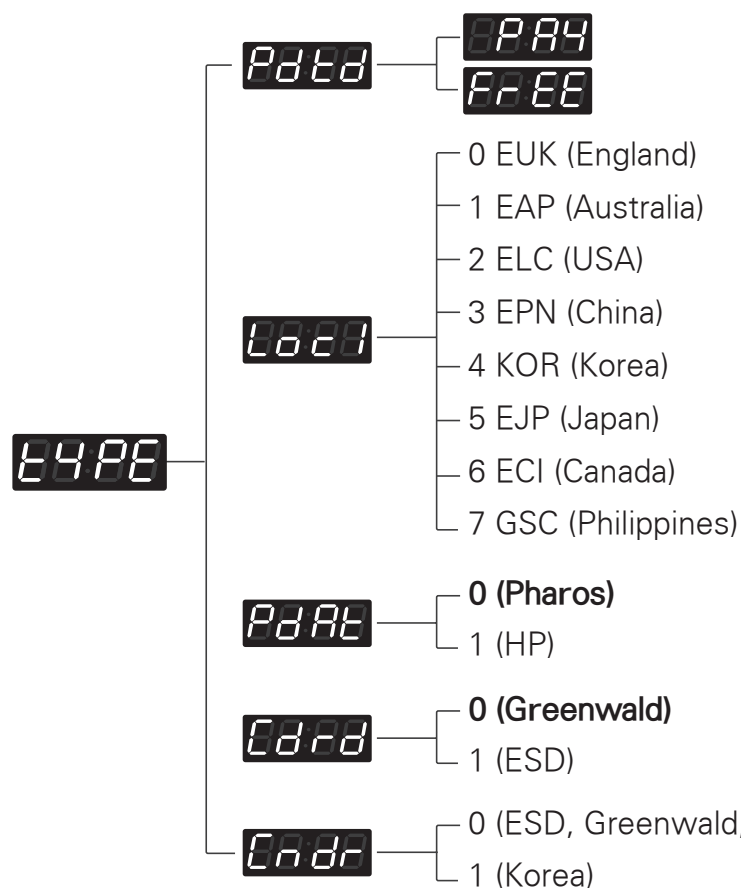

25. How to enter the **E4PE**

	Button	Display
Entering set up mode. You will see LqC1 	Press the Hot button.	
	Press the Warm or the Cold button until SEUP appears in the display.	
	Press the Start button.	
	Press the Warm or the Cold button until E4PE appears in the display.	

Structure of **E4PE**

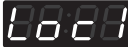

Content of **E4PE**

-  • Product type
-  • Currency choice
-  • PDA type
-  • Card reader type
-  • Coin drop type

NOTE

- Pay means card or coin type.
- Default type is coin type.
If you want to change coin type to card type, you need to setup vend type in fea1. (refer to FEA1 function)
- Free means OPL type.

PROGRAMMING MODE - TEST MODE

Diagnostic tests: **EE5E** (display)

This program has been added for testing the washer and detecting errors.

Entering the test mode

Data Name	Button	Display	Description
Entering the test mode	1. Entering programming mode	L9C1	Insert service card (card type), turn on/off toggle switch (Coin type).
	2. Hot	EE5E	Press the Hot button. Then EE5E appears in the display.
	3. Start	L9C1	Enter the diagnostic test mode.

1. **L9C1**

According to pressing Start button, test move to the next step.





Number of times the Start button is pressed	Check Point	Display
None		L9C1
1time	Turns on all lamps and locks the door	Displays 1U:XX, 1g:XX and 12:X0 alternately (Version)
2 times	Tumble Clockwise.	rpm (40~50)
3 times	Low Speed Spin	rpm (600)
4 times	High Speed Spin	rpm (1150)
5 times	Inlet valve for main water turns on.	Water level frequency (255~)
6 times	Inlet valve for hot wash turns on.	Water level frequency (255~)
7 times	Inlet valve for softener turns on.	Water level frequency (255~)
8 times	Inlet valve for bleach turns on.	Water level frequency (255~)
9 times	Tumble counter clockwise.	rpm (40~50)
10 times	Turn on Circulation Pump.	Water level frequency (255~)
11 times	Drain Pump turns on.	Water level frequency (255~)
12 times	Turns on all lamps.	Displays 1U:XX, 1g:XX and 12:X0 alternately
13 times	Button Checks.	
14 times	High Speed Spin	rpm (1150)
15 times	17:00 PDA Signal Check	17:00 this function is not applied in this machine
16 times		L9C1

! NOTE

- Make sure the drum is empty when a diagnostic test is performed. Do not use **L9C2**.

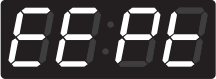
2. Factory reset - **EE Pt**











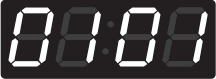

After factory reset, machine information is changed to the default value.

Entering set up mode. You will see LqC1	Button	Display
	Press the Warm or the Cold button until EE Pt appears in the display.	
	Press the Start button.	
	Press the Warm button until 00:23 appears in the display.	
	Press the Start button, then factory reset is done. LqC1 is displayed.	
	1. Continue to set up the next mode. 2. Stop the change of setup value and go back to ready mode. <ul style="list-style-type: none"> • Coin type – Turn on/off toggle switch. • Card type – Insert the service card. • OPL type – Push the Hot button twice. 	

! NOTE







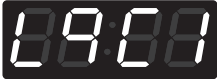

- Washing time 10 minutes
- Rinse cycle twice
- Top spin speed 1000 rpm
- Add SUPER WASH 3 minutes extra wash and one extra rinse

3. Time set up

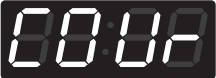
	Button	Display
Entering set up mode. You will see LqC1 	Press the Warm or the Cold button until  appears in the display.	
	Press the Start button. The display will cycle through 2000 -> 0101 -> Sat -> 0000 repeatedly.	
	Press the Start button.	
	Press Warm (+) or Cold (-) button to select year between 2000 and 2099.	
	Press the Start button. The machine sets up the year, then advances to the next process automatically.	
	Press Warm (+) or Cold (-) button to select a month between 01 and 12.	
	Press the Start button. The machine sets up the month, then advances to the next process automatically.	
	Press Warm (+) or Cold (-) button to select the day between 01 and 31.	
	Press the Start button. The machine sets up the day, then advances to the next process automatically.	
	Press Warm (+) or Cold (-) button to select the hour between 00 and 23.	
	Press the Start button. The machine sets up the hour, then advances to the next process automatically.	
	Press Warm (+) or Cold (-) button to select minute between 00 and 59.	
	Press the Start button. The machine sets up the minute.	
	1. Continue to set up the next mode. 2. Stop the change of setup value and go back to ready mode. <ul style="list-style-type: none"> • Coin type - Turn on/off toggle switch. • Card type - Pull the service card. • OPL type - Push the Hot button twice. 	





4. Courtesy cycle

A courtesy cycle is like a complimentary cycle given to the customer when the washer goes out of order after the customer has made the payment to wash clothes.

	Button	Display
Entering set up mode. You will see LqC1 	Press the Warm or the Cold button until  appears in the display.	
	Press the Start button.	
	Press the Warm button until  appears in the display.	
	Press the Start button.	
	Select the cycle you desire.	
	Press the Start button. Display will show the remaining time and Start.	

5. Cycle Kill

Coin / OPL type











Entering set up mode. You will see LqC1	Button	Display
	Press the Warm or the Cold button until FILL appears in the display.	
	Press the Start button.	
	Press the Warm button until 00:17 appears in the display.	
	Press the Start button. Start drain and display spin time.	Display spin time
	Display End with beeping.	
	Go back to ready mode.	

Card type

Insert cycle kill card.	Description	Display
	Display spin time.	Spin Time
	Begin to drain.	Spin Time
	Remove cycle kill card.	
	Go back to ready mode.	

6. Password -

How to change the password.









	Button	Display
<p>Entering set up mode. You will see LqC1</p> 	Press the Warm or the Cold button until  appears in the display.	
	Press the Start button.	
	Press the Warm button until  appears in the display.	
	Set up the number you want By pressing Warm or the Cold button. For example, If you want to change password number to No. 5. Press the Warm button until  appears in the display.	
	Press the Start button, then Password change is done.  is displayed.	
	1. Continue to set up the next price. 2. Stop the change of setup value and go back to ready mode. <ul style="list-style-type: none"> • Coin type - Turn on/off toggle switch. • Card type - Pull the service card. • OPL type – Push the Hot button twice. 	

! NOTE

- Default password is 3.
- If you want to change the password, you must know the present password.

7. Tub clean -

To clean up the tub, please run the TUB CLEAN cycle.

Entering set up mode. You will see LqC1	Button	Display
	Press the Warm or the Cold button until  appears in the display.	
	Press the Start button.	
	Press the Warm button until  appears in the display.	
	Press the Start button, then tub clean reset is done.  is displayed.	
	1. Continue to set up the next price. 2. Stop the change of setup value and go back to ready mode. <ul style="list-style-type: none"> • Coin type - Turn on/off toggle switch. • Card type - Pull the service card. • OPL type - Push the Hot button twice. 	

NOTE

- Never load laundry while using TUB CLEAN. The laundry may be damaged or become contaminated. Make sure to clean the washer tub when it is empty.
- Leave the door open after finishing the laundry to keep the tub clean.
- TUB CLEAN should be repeated monthly.
- Safely and conveniently secure the door slightly ajar with a magnetic door plunger. This will promote air circulation and allow the interior of the machine to dry.

PROGRAMMING MODE - COLLECT MODE

Collect information data : **CLCE** (display)

The washer collects the usage data so that the owner can check various information like number of various cycles used, how many times card or coins used, etc.

Entering the collect mode

Data Name	Button	Display	Description
Entering the collect mode	1. Entering the programming mode.	L901	Insert service card (card type), turn on/off toggle switch (coin type).
	2. Hot	EESE	Press the Hot button until EESE appears in the display.
	3. Warm(+), Cold(-)	CLCE	Press the Warm (+), Cold (-) button until CLCE appears in the display.
	4. Start	29P2	Enter the Collect information data.
	5. Warm(+), Cold(-)	xxxx	Move to each data list that you want to check by pressing with Warm (+) or Cold (-) button.
	6. Start	xxxx	Display the value of selected data list
	7. Hot	CLCE	Move to upper level or Comes back to Idle State

❖ Check the collect information reference to the follow lists. The lists are displayed by abbreviations.

Collect Mode Data lists

No.	Abbreviation	Meaning	Description
1	rgPr	Regular Price	0~199 nickels (\$0.00 ~ \$9.95)
2	rgCP	Regular Delicates Price	0~199 nickels (\$0.00 ~ \$9.95)
3	rgrP	Regular Warm & Cold Price	0~199 nickels (\$0.00 ~ \$9.95)
4	rgHP	Regular Hot Price	0~199 nickels (\$0.00 ~ \$9.95)
5	dELC	Dryer Moisture Sense	0: disable 1: enable
6	ltrC	Interval Regular Cycles	Number of Regular cycles (0~65535)
7	ltCC	Interval Regular Delicates Cycles (60°C NORMAL)	Number of Regular Cold cycles (0~65535)
8	ltAC	Interval Regular Warm & Cold Cycles (75°C HOT, PERM. PRESS)	Number of Regular Warm cycles (0~65535)
9	ltHC	Interval Regular Hot Cycles (90°C MEDICAL)	Number of Regular Hot cycles (0~65535)
10	ltSC	Interval Super Cycles	Number of Super cycles (0~65535) (Washer Only)
11	lttF	Interval Topoff Cycles	Number of Topoff cycles (0~65535) (Dryer Only)
12	ltUC	Interval Service Cycles	Number of Service cycles (0~65535)
13	ltFC	Interval Token Cycles	Number of Token cycles (0~65535)
14	ACrC	Accumulated Regular Cycles	Number of Regular cycles (0~65535)
15	ACCC	Accumulated Regular Delicates Cycles (60°C NORMAL)	Number of Regular Cold cycles (0~65535)
16	ACAC	Accumulated Regular Warm & Cold Cycles (75°C HOT, PERM. PRESS)	Number of Regular Warm cycles (0~65535)
17	ACHC	Accumulated Regular Hot Cycles (90°C MEDICAL)	Number of Regular Hot cycles (0~65535)
18	ACSC	Accumulated Super Cycles	Number of Super cycles (0~65535) (Washer Only)
19	ACtF	Accumulated Topoff Cycles	Number of Topoff cycles (0~65535) (Dryer Only)
20	ACUC	Accumulated Service Cycles	Number of Service cycles (0~65535)
21	ACFC	Accumulated Token Cycles	Number of Token cycles (0~65535)
22	ACrt	Accumulated Run Time	Number of Running minutes (0~65535)
23	ltnr	Interval No Runs	Money inserted, but no run
24	lttb	Interval Trouble Cycles	No money, but ran
25	ltPd	Interval Power Downs	Number of power down
26	ltdd	Interval Unauthorized Service Door Openings	Number of Unauthorized Service Door Openings (0~ 255)
27	ltAd	Interval Authorized Service Door Openings	Number of Authorized Service Door Openings (0~255)
28	ltUC	Interval Unauthorized Coin Vault Openings	Number of Authorized Service Door Openings (0~255)
29	ltAC	Interval Authorized Coin Vault Openings	Number of Authorized Coin Vault Openings (0~255)
30	lttl	Interval Total Income	Amount of money cycle(\$ 0 ~ \$ 65535)
31	ACtl	Accumulated Total Income	Amount of money cycle(\$ 0 ~ \$ 65535)
32	lttC	Interval Total Cycles	Number of Total cycle(\$ 0 ~ \$ 65535)
33	ACtC	Accumulated Total Cycles	Number of Total cycle(\$ 0 ~ \$ 65535)
34	SCPr	Super Cycle Price	\$0.00 ~ \$9.95
35	toPr	Top Off Price	\$0.00 ~ \$9.95
36	ltd	Interval Money	Amount of money for regular cycle(\$ 0 ~ \$ 65535)
37	Acd	Accumulated Money	Amount of money for regular cycle(\$ 0 ~ \$ 65535)
38	ltSd	Interval Superwash Money	Amount of money for superwash cycle(\$ 0 ~ \$ 65535)
39	ACSd	Accumulated Superwash Money	Amount of money for superwash cycle(\$ 0 ~ \$ 65535)

* Interval Cycles (Interval means Since last data collecting)

* Accumulated Cycles (Accumulated means Total cycles in washer/dryer's life time not include service cycles or trouble cycles)

* Authorized: Service Door Openings with PDA Communication (Open Service door Within 20 seconds After communicating with PDA)

* Unauthorized: Service Door Openings without PDA Communication

* These items (No. 30~33) are not applied this program

MAINTENANCE

Care after wash

After the cycle is finished, wipe the door and the inside of the door seal to remove any moisture. Leave the door open to dry the washer tub interior. Wipe the body of the washing machine with a dry cloth to remove any moisture

⚠ WARNING

- **Unplug the washer before cleaning to avoid the risk of electric shock.** Failure to follow this warning can cause serious injury, fire, electrical shock, death.
- **Never use harsh chemicals, abrasive cleaners, or solvents to clean the washer.** They will damage the finish.
- **Do not use volatile substances (benzene, paint thinner, alcohol, acetone, etc.) or detergents with strong chemical components when cleaning the washing machine.** Doing so may cause discoloration or damage to the machine, or it may cause a fire.

Storing the Washer

If the washer will not be used for an extended period of time and is in an area that could be exposed to freezing temperatures:

1. Turn off water supply tap.
2. Disconnect hoses from water supply and drain water from hoses.
3. Plug the power cord into a properly grounded electrical outlet.
4. Add 1 gallon of nontoxic recreational vehicle (RV) antifreeze to the empty wash drum. Close door.
5. Select the spin cycle and let washer spin for 1 minute to drain out all the water.
6. Unplug the power cord, dry the drum interior with a soft cloth, and close the door.
7. Remove the inserts from the dispenser. Drain any water in compartments and dry the compartments.
8. Store the washer in an upright position.
9. To remove the antifreeze from the washer after storage, run washer through a complete cycle using detergent.

Do not add laundry!

ⓘ NOTE

- Not all of the RV antifreeze will be expelled.
- Weekly cleaning of the detergent dispenser will ensure problem free operation.

Cleaning the Dispenser

1. The dispenser should be cleaned periodically to remove buildup from detergent and other laundry products.

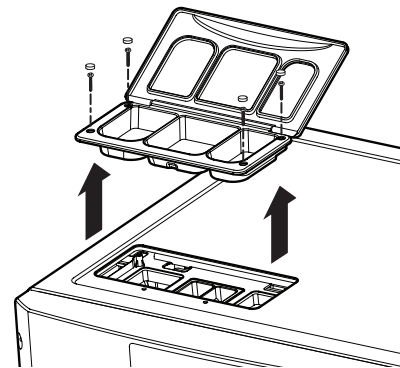

2. Remove the inserts from the drawer, and clean them with warm water and a soft cloth or brush to remove any residue or buildup.

Wipe out the inside of the drawer opening with a damp cloth. Reassemble the drawer and reinstall in the drawer opening.

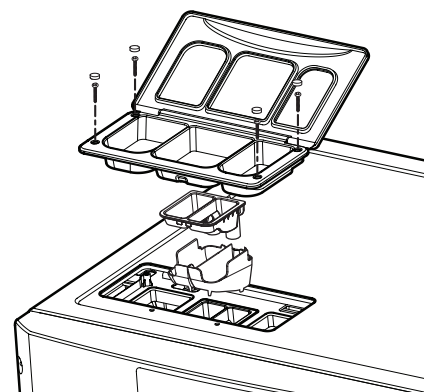

ⓘ NOTE

- Do not use anything other than water to clean the drawer, inserts, and drawer opening.

Cleaning the water inlet filters

Clean the water inlet filters periodically to prevent clogging. Take extra care to clean the water inlet filters for areas using hard water. Water may not be supplied if there are foreign objects, such as rust, sand, or stones in the water inlet filters.

- 1 Pull out the plug to turn off the washing machine.
- 2 Turn off the faucets connected with the water inlets.
- 3 Remove the water inlet hoses.

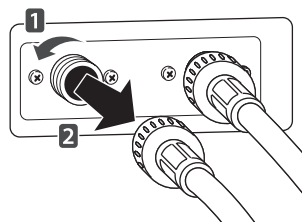

- 4 Pull out the water inlet filter.

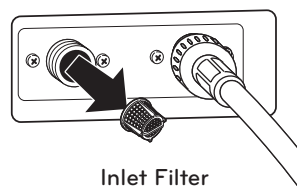

- 5 Remove foreign objects from the water filter inlet.
 - Soak the water filter inlets in white vinegar or a lime scale remover or use a toothbrush to remove foreign objects and rinse thoroughly.
- 6 Press the water filter inlets back into place.
- 7 Reattach the water lines to the washing machine.

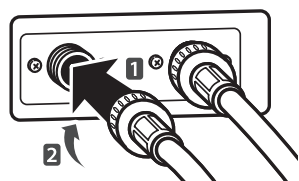

⚠ WARNING

- **Unplug the power cord and turn off the faucets before cleaning.** Failure to do so may cause electric shock.
- **Do not use the washing machine without the inlet filters.** If you use the washing machine without the inlet filters it will cause leaks and malfunction.
- If you use the washing machine in an area with hard water, the inlet filter may clog due to lime buildup.

ⓘ NOTE

- **! E** message will blink on the display when the water pressure in the detergent drawer is weak or an inlet filter is clogged with dirt. Clean the inlet filter.

Cleaning the drain pump filter

The washing machine fails to drain if the drain pump filter is clogged. Periodically clean the drain filter to prevent clogging with foreign objects.

- 1 Pull out the plug to turn off the washing machine.
- 2 Open the drain pump filter cover.

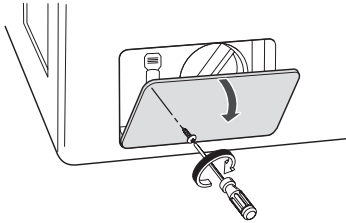

- 3 Unclip the drain hose and remove the plug from the drain hose to drain the remaining water.

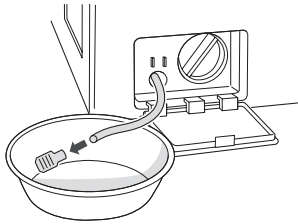

- 4 Twist the pump filter counterclockwise to remove.

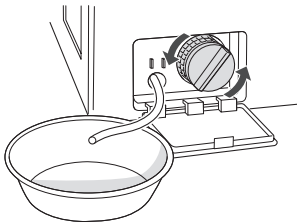

- 5 Clean the pump filter and opening.

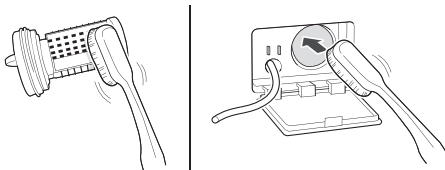

- 6 Recap the plug onto the drain hose and reattach the drain hose.

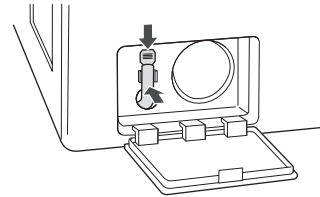

- 7 Insert the drain pump filter.

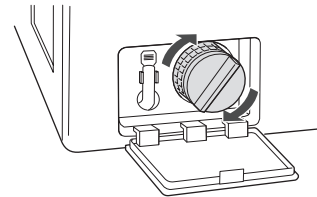

- 8 Close the drain pump filter cover.

⚠ WARNING

- **Make sure to pull out the plug before cleaning.** Failure to do so may cause electric shock.
- Opening the drain filter will result in water overflowing if there is water in the washer tub. **Make sure to check if the water is completely drained before opening the drain filter.**
- If you use the washing machine with the drain filter reassembled incorrectly after cleaning it, or if you use the machine without the filter, it may cause leaks or malfunction of the washing machine.

ⓘ NOTE

- **DE** message will blink when the drain pump filter is clogged with dirt. Clean the drain pump filter.

Clean the door seal

Clean the door seal once a month to prevent build-up of dirt in the door seal.

- 1 Wear rubber gloves and protective goggles.
- 2 Dilute 3/4 cup (177 ml) of liquid chlorine bleach in 1 gallon (3.8 L) of water.
- 3 Soak a sponge or a soft cloth in this diluted solution and wipe down all around the door seal.
- 4 Wipe any moisture with a dry towel or cloth after cleaning.
- 5 Leave the door open to allow the door seal to dry completely.

⚠ CAUTION

- Cleaning the door seal with an undiluted solution may cause malfunction of the door seal and washing machine parts.

Clean the drum, TUB CLEAN

Using the washing machine in a humid space for a long period of time may lead to a buildup of black mold and germs in the air inside the washer tub and affect your health. If you clean the washer tub regularly on a monthly basis using TUB CLEAN it will keep the washer tub clean for hygienic use.













- 1 Add tub cleaner or lime scale remover into the detergent dispenser drawer.
 - Do not exceed the maximum detergent limit line when you add it. Detergent may remain in the washer tub after cleaning.
 - When you use liquid chlorine bleach, load it into the liquid chlorine bleach compartment. When you use a powdered cleaner, add it into the main wash detergent compartment.
 - When you use cleaning tablets, place them directly into the washer tub. (Do not add cleaning tablets to the drawer.)
- 2 Do operate tub clean. (please refer to 58 page about tub)

ⓘ NOTE

- Never load laundry while using TUB CLEAN. The laundry may damage or become contaminated. Make sure to clean the washer tub when it is empty.
- Leave the door open after finishing the laundry to keep the tub clean.
- TUB CLEAN should be repeated monthly.
- Safely and conveniently secure the door slightly ajar with a magnetic door plunger. This will promote air circulation and allow the interior of the machine to dry.

ERROR MODE

Meaning of Error Codes that LED displays during occurrence of problem.

Problem	Possible Cause	Solution
	<ul style="list-style-type: none"> • Water supply is not adequate in area. • Water supply taps are not completely open. • Water inlet hose is bent. • The filter of the inlet hose clogged. 	Check another tap in the house. Fully open tap. Straighten hose. Check the filter of the inlet hose.
	<ul style="list-style-type: none"> • Drain hose is bent or clogged. • The drain filter is clogged. 	Clean and straighten the drain hose. Clean the drain filter.
	<ul style="list-style-type: none"> • Load is too small. • Load is out of balance. • The appliance has an imbalance detection and correction system. If individual heavy articles are loaded (bath mat, bath robe, etc.) and the imbalance is too great, after several attempts to restart the spin cycle the machine will stop and the error code will be displayed. 	Add 1~2 similar items to help balance the load. Rearrange load to allow proper spinning.
	<ul style="list-style-type: none"> • Is the door opened or not completely closed? 	Close the door completely. * If it will not open, call for service.
	<ul style="list-style-type: none"> • Door lock is broken. 	Check the door switch.
	<ul style="list-style-type: none"> • The water overfills due to a faulty water valve. 	Close the water tap. Unplug the power plug. Call for service.
	<ul style="list-style-type: none"> • The water level sensor malfunction. 	
	<ul style="list-style-type: none"> • Overload in motor. 	Restart the cycle after 30 minutes. If  is not released, call for service.
	<ul style="list-style-type: none"> • Disconnection of card reader cable. 	Check the card reader wire.
	<ul style="list-style-type: none"> • Too much detergent is used. 	This is not an error. It indicates a suds removal routine. It will clear and restart the cycle when the suds are gone.
		Unplug the power plug and call for service.

POWER FAIL RECOVERY

In case of power failure, the machine stops running but the time display remains on, showing the time just before power failure.

DEFAULT WASHER SETTINGS

Default Settings	Default
Wash Time (Minutes)	10 Minutes
Rinse Time (Minutes)	16 Minutes
Spin Time (Minutes)	10 Minutes
Rinsing times	Twice
Coin #1 Value	25¢
Coin #2 Value (E-suds)	25¢
Vend Price	\$1.00
Add super wash price	25¢
Top Spin speed	1000 rpm

SPECIFICATIONS

Model GCWP1069***	
Name	Front-loading Washing Machine
Power supply	120 V~ 60 Hz
Size	686 mm (W) X 767 mm (D) X 983 mm (H), 129.1 cm (D with door open) 27" (W) X 30 ¹ / ₅ " (D) X 38 ¹¹ / ₁₆ " (H), 50 ¹³ / ₁₆ " (D with door open)
Weight	190 lbs. (87 kg)
Wash capacity	3.63 cu.ft (IEC:4.2 cu.ft)
Spin speed	1150 rpm max.
Permissible water pressure	14.5~116 psi (100~800 kPa)

NOTE

- Specifications subject to change by manufacturer.

