

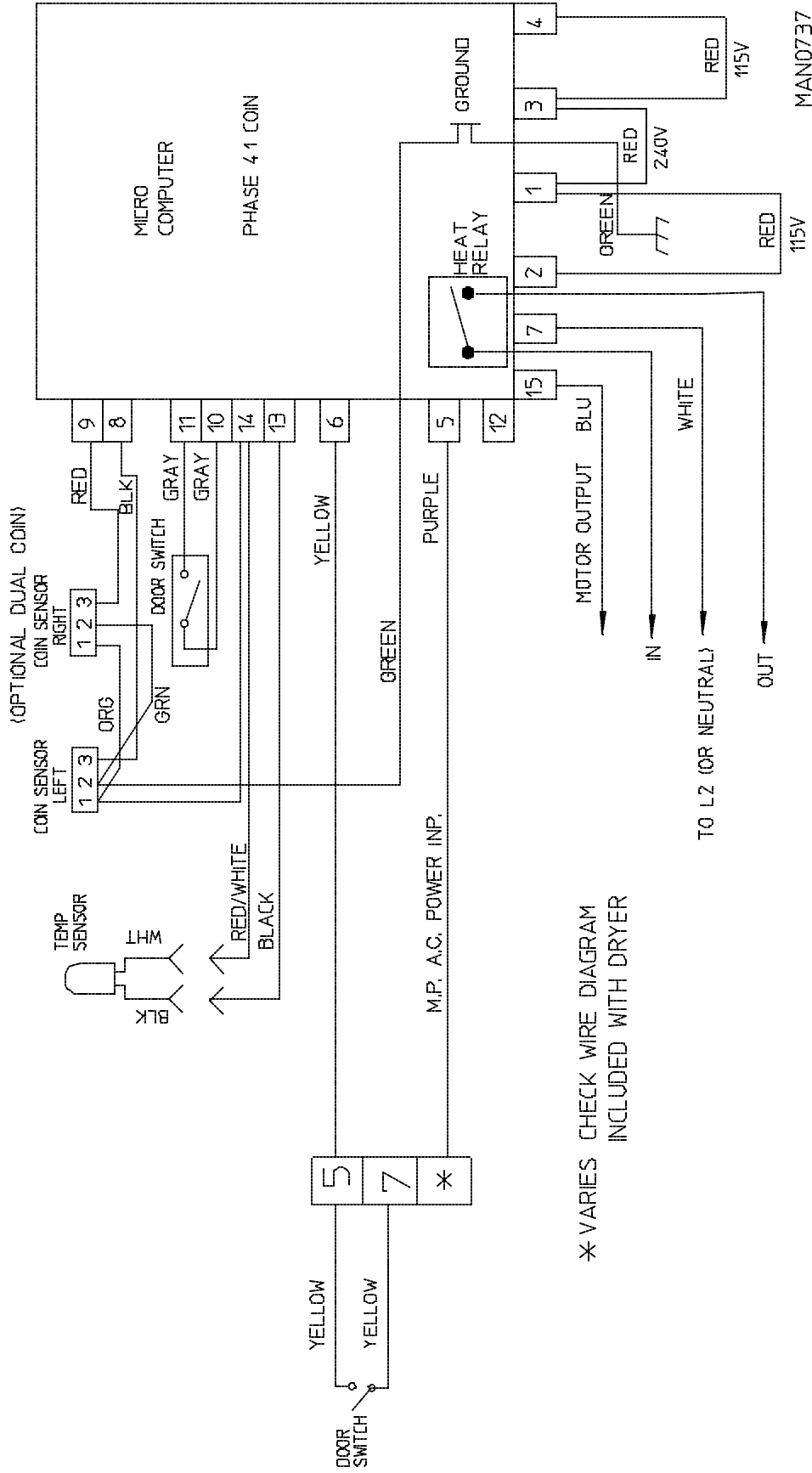

**AD-15, 25, 30, 285, 230, 50  
Coin Circuit Diagrams  
Service Booklet**

**American Dryer Corporation**  
88 Currant Road  
Fall River, MA 02720-4781  
Telephone: (508) 678-9010 / Cable: AMDRY / Fax: (508) 678-9447

# PHASE 4.1 COIN CONTROLLER CIRCUITS





# PHASE 4.1 COIN MOTOR CIRCUIT

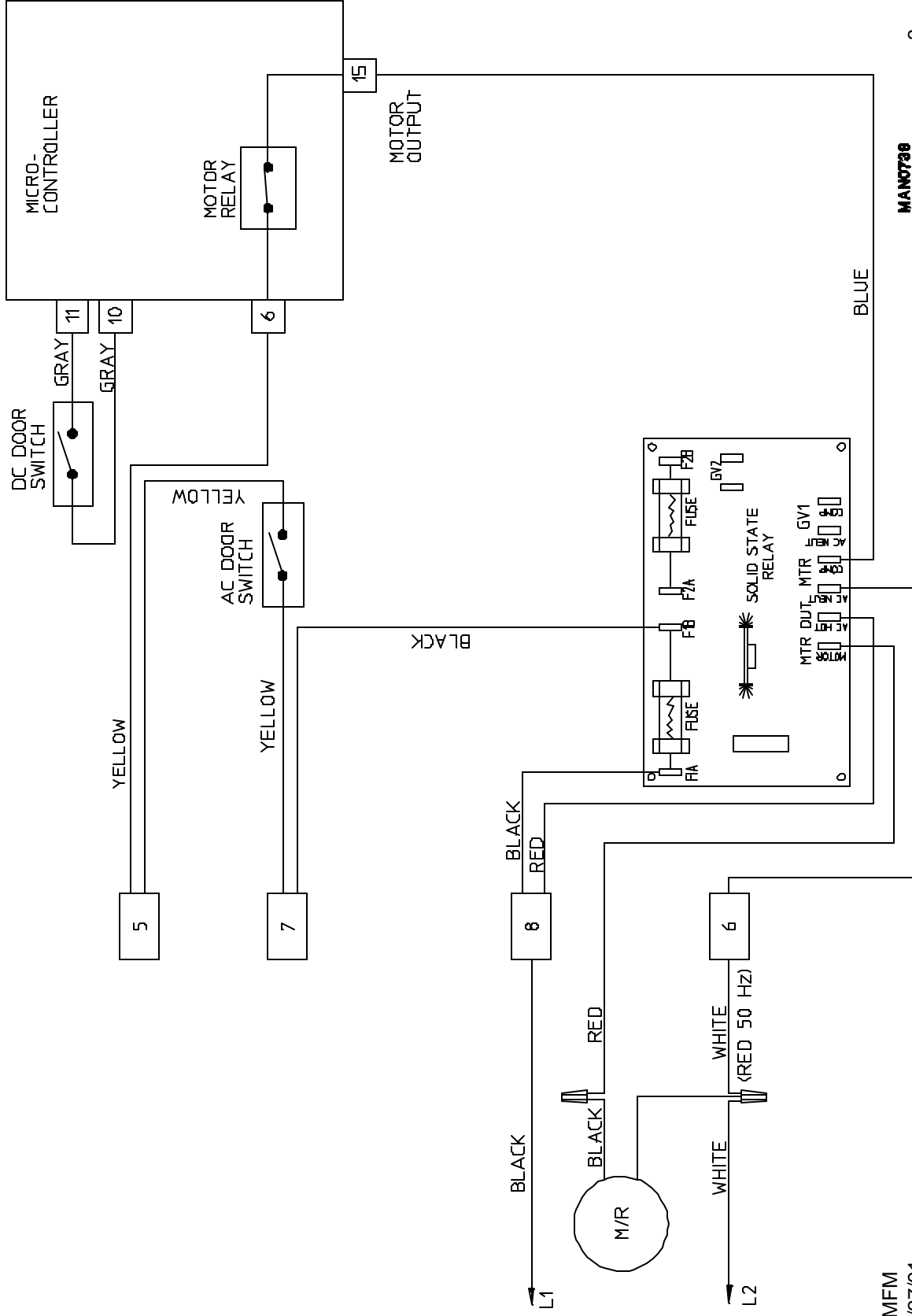

# D.S.I. HEAT CIRCUIT

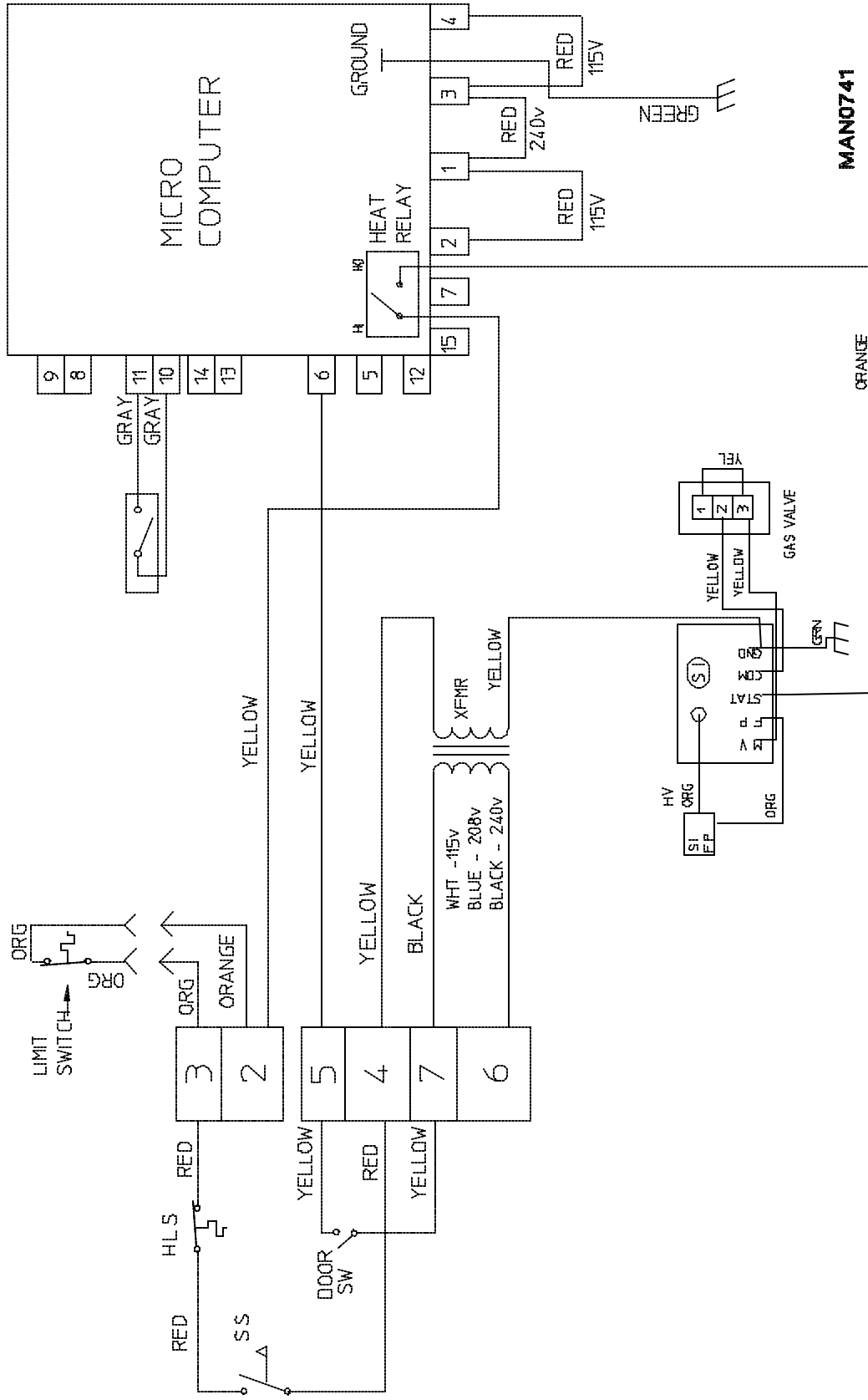

# M.P. HEAT SENSOR CIRCUIT

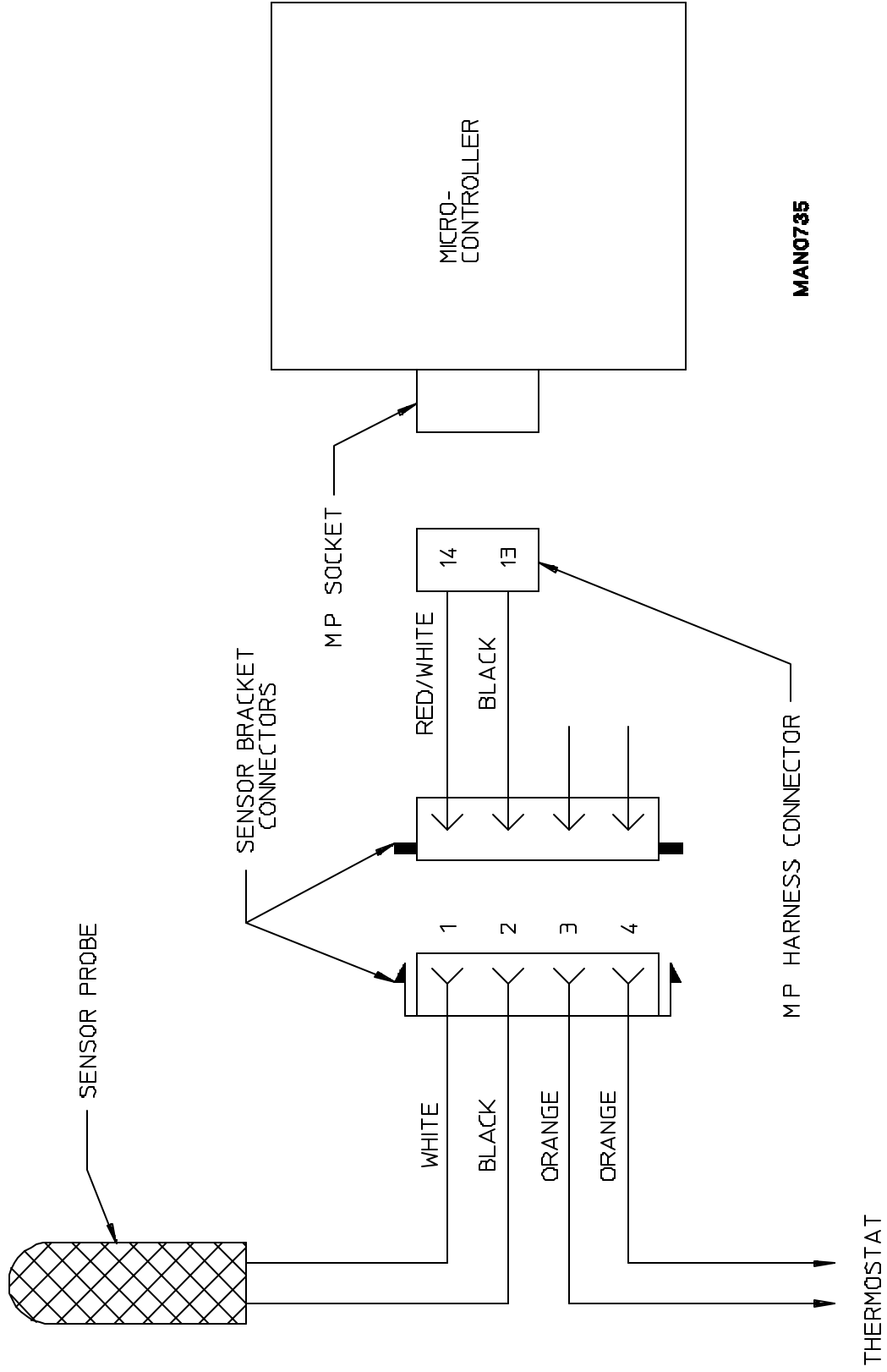

# PHASE 3 + 4 COIN "DSFL" DISPLAY CONDITION

- 1 M.P. TEMP. SENSOR DEFECTIVE
- 2 LOOSE CONNECTION AT SENSOR BRK'T CONNECTOR.
- 3 LOOSE CONNECTION AT M.P. HARNESS CONNECTOR
4. BREAK IN WIRING OR WIRE SHORTED TO GROUND.
- 5 MP CONTROLLER DEFECTIVE.

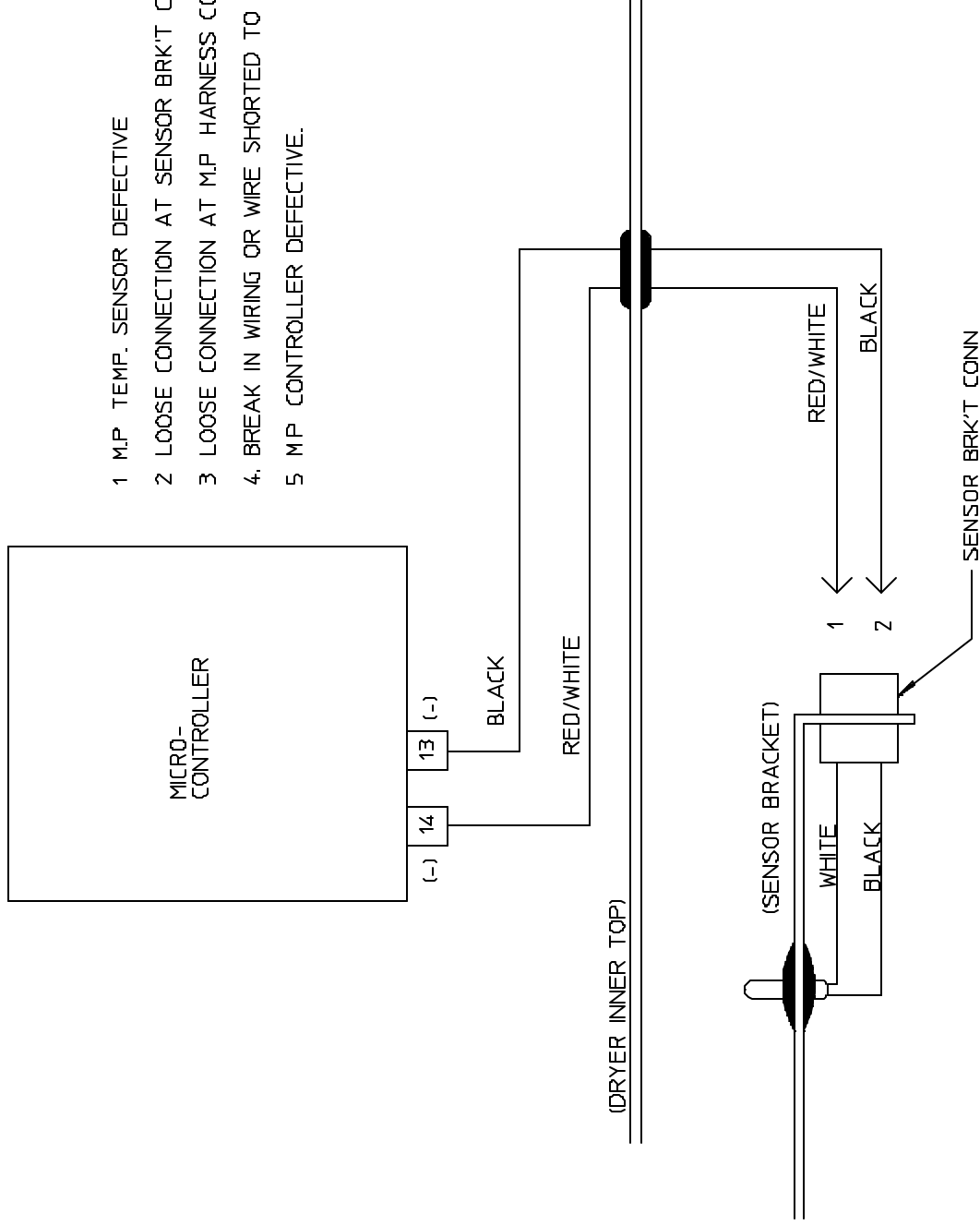



# PHASE 4.1 NEW STYLE DOOR SWITCH CIRCUIT

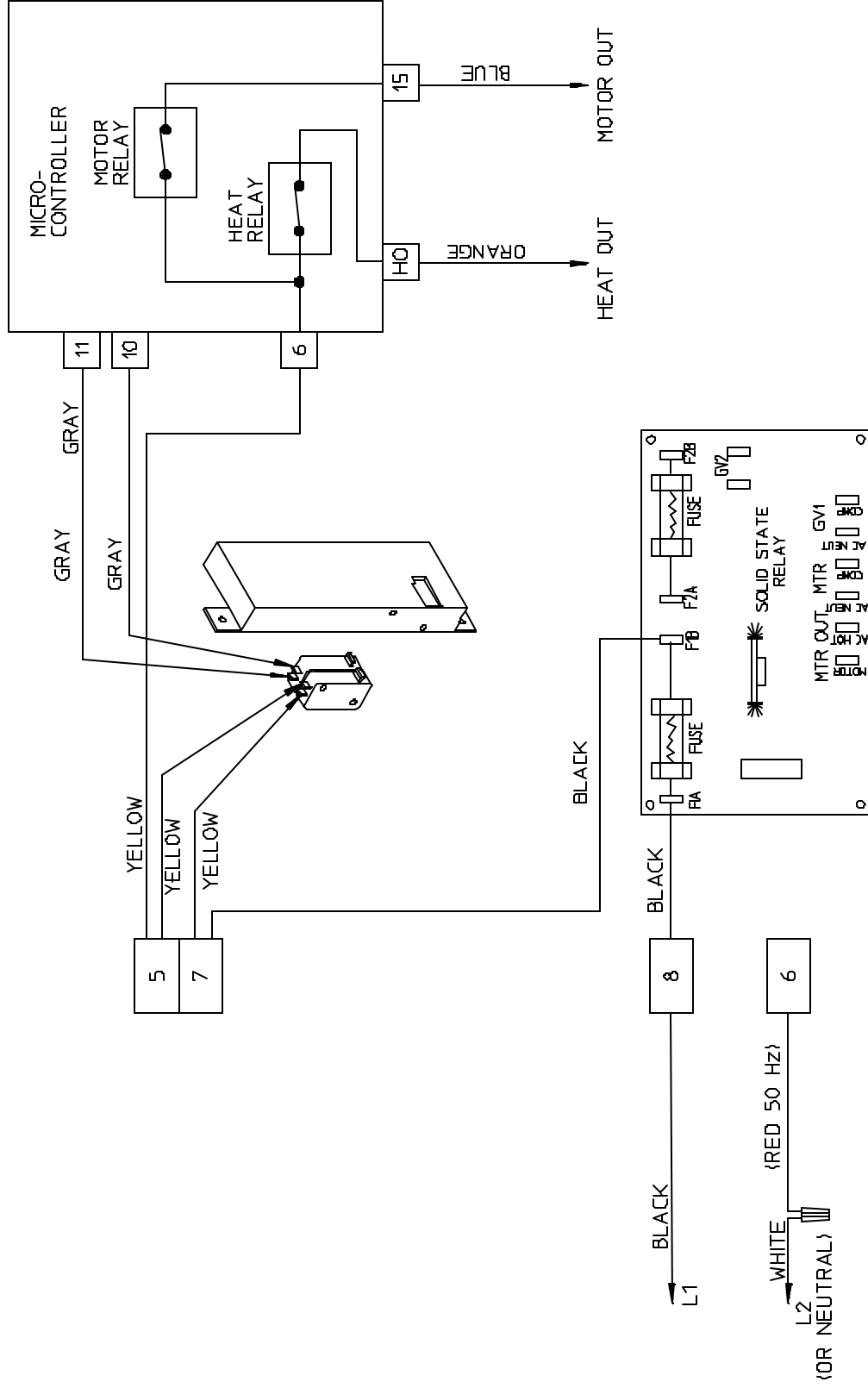

# PHASE 3 + 4 COIN "DOOR" DISPLAY CONDITION

- 1 DOOR SWITCH DEFECTIVE OR OUT OF ADJUSTMENT
- 2 LOOSE CONNECTION AT HARNESS CONNECTOR
- 3 LOOSE CONNECTION AT MP HARNESS CONNECTOR
4. BREAK IN WIRING.

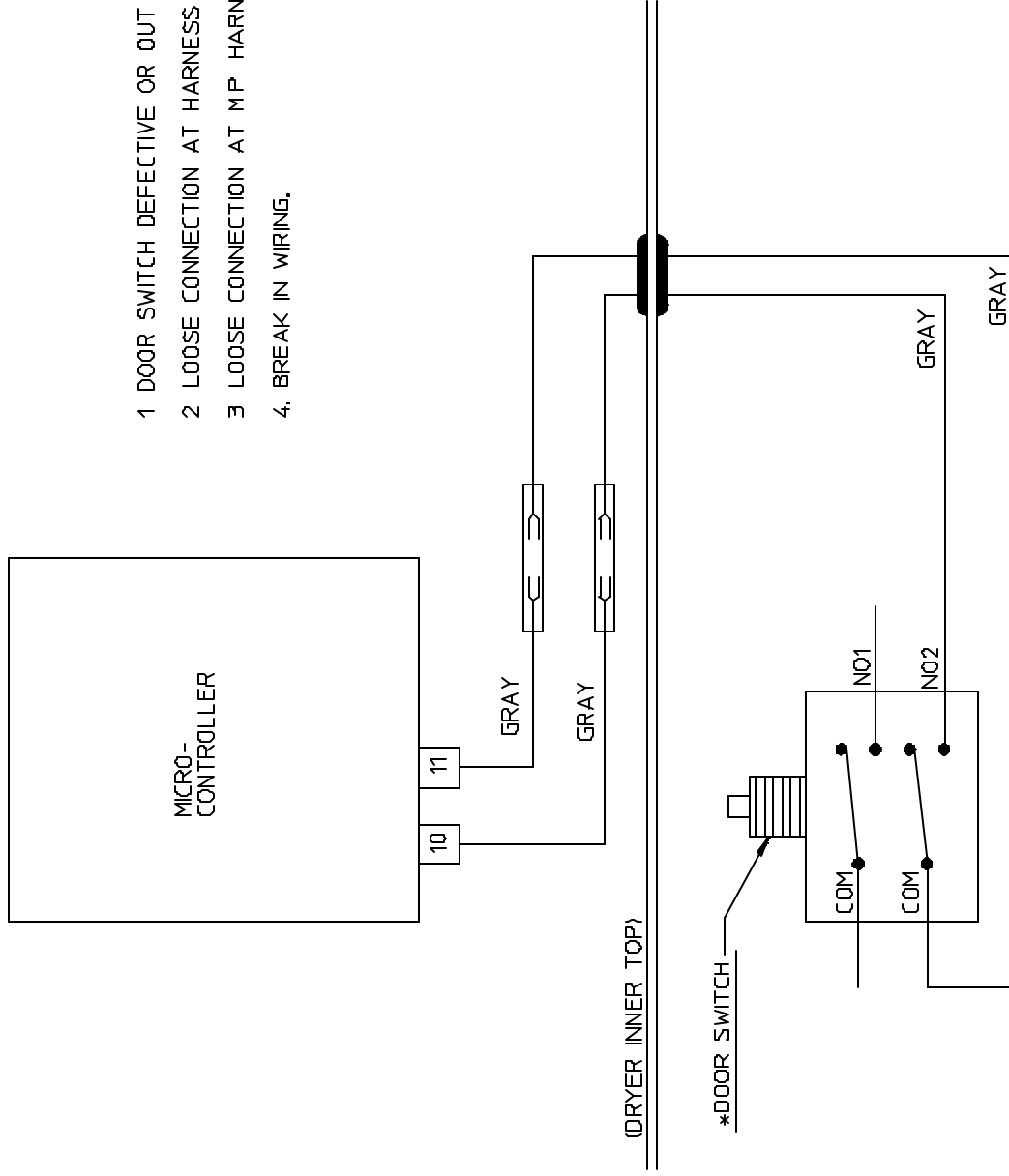

MAN0734

MFM  
9/27/91

ADC 450127 1-11/13/91-100 2-03/25/92-100 3--04/11/92-100  
4-06/03/92-100 5-08/17/92-100 6\*-09/21/92-200  
7-12/02/93-250

