

AD-360X2

(Phase 7)

Installation Manual

WARNING: For your safety the information in this manual must be followed to minimize the risk of fire or explosion or to prevent property damage, personal injury or death.

— Do not store or use gasoline or other flammable vapors and liquids in the vicinity of this or any other appliance.

— **WHAT TO DO IF YOU SMELL GAS:**

- Do not try to light any appliance.
- Do not touch any electrical switch; do not use any phone in your building.
- Clear the room, building or area of all occupants.
- Immediately call your gas supplier from a neighbor's phone. Follow the gas supplier's instructions.
- If you cannot reach your gas supplier, call the fire department.

— Installation and service must be performed by a qualified installer, service agency or the gas supplier.

AVERTISSEMENT: Assurez-vous de bien suivre les instructions données dans cette notice pour réduire au minimum le risque d'incendie ou d'explosion ou pour éviter tout dommage matériel, toute blessure ou la mort.

— Ne pas entreposer ni utiliser d'essence ni d'autres vapeurs ou liquides inflammables à proximité de cet appareil ou de tout autre appareil.

— **QUE FAIRE SI VOUS SENTEZ UNE ODEUR DE GAZ:**

- Ne pas tenter d'allumer d'appareils.
- Ne touchez à aucun interrupteur. Ne pas vous servir des téléphones se trouvant dans le bâtiment.
- Évacuez la pièce, le bâtiment ou la zone.
- Appelez immédiatement votre fournisseur de gaz depuis un voisin. Suivez les instructions du fournisseur.
- Si vous ne pouvez rejoindre le fournisseur de gaz, appelez le service des incendies.

— L'installation et l'entretien doivent être assurés par un installateur ou un service d'entretien qualifié ou par le fournisseur de gaz.



For replacement parts, contact the reseller from which the dryer was purchased or

American Dryer Corporation

88 Currant Road

Fall River MA 02720-4781 USA

Telephone: (508) 678-9000 / Fax: (508) 678-9447

e-mail: techsupport@amdry.com

www.amdry.com

Retain This Manual In A Safe Place For Future Reference

American Dryer Corporation products embody advanced concepts in engineering, design, and safety. If this product is properly maintained, it will provide many years of safe, efficient, and trouble free operation.

ONLY qualified technicians should service this equipment.

OBSERVE ALL SAFETY PRECAUTIONS displayed on the equipment or specified in the installation manual included with the dryer.

The following “**FOR YOUR SAFETY**” caution **must be** posted near the dryer in a prominent location.

FOR YOUR SAFETY

Do not store or use gasoline or other flammable vapors and liquids in the vicinity of this or any other appliance.

POUR VOTRE SÉCURITÉ

Ne pas entreposer ni utiliser d'essence ni d'autres vapeurs ou liquides inflammables à proximité de cet appareil ou de tout autre appareil.

We have tried to make this manual as complete as possible and hope you will find it useful. **ADC** reserves the right to make changes from time to time, without notice or obligation, in prices, specifications, colors, and material, and to change or discontinue models. The illustrations included in this manual may not depict your particular dryer **exactly**.

Important

For your convenience, log the following information:

DATE OF PURCHASE _____ MODEL NO. **AD-360X2 Phase 7**

RESELLER'S NAME _____

Serial Number(s) _____

Replacement parts can be obtained from your reseller or the **ADC** factory. When ordering replacement parts from the factory, you can FAX your order to **ADC** at (508) 678-9447 or telephone your order directly to the **ADC** Parts Department at (508) 678-9000. Please specify the dryer **model number** and **serial number** in addition to the **description** and **part number**, so that your order is processed accurately and promptly.

“IMPORTANT NOTE TO PURCHASER”

Information **must be** obtained from your local gas supplier on the instructions to be followed if the user smells gas. These instructions **must be** posted in a prominent location near the dryer.

IMPORTANT

YOU MUST DISCONNECT AND LOCKOUT THE ELECTRIC SUPPLY AND THE GAS SUPPLY BEFORE ANY COVERS OR GUARDS ARE REMOVED FROM THE MACHINE TO ALLOW ACCESS FOR CLEANING, ADJUSTING, INSTALLATION, OR TESTING OF ANY EQUIPMENT PER OSHA (Occupational Safety and Health Administration) STANDARDS.

“Caution: Label all wires prior to disconnection when servicing controls. Wiring errors can cause improper operation.”

«Attention: Au moment de l’entretien des commandes, étiquetez tous les fils avant de les débrancher. Des erreurs de câblage peuvent entraîner un fonctionnement inadéquat et dangereux.»

CAUTION

DRYERS SHOULD NEVER BE LEFT UNATTENDED WHILE IN OPERATION.

WARNING

**CHILDREN SHOULD NOT BE ALLOWED TO PLAY ON OR NEAR THE DRYER(S).
CHILDREN SHOULD BE SUPERVISED IF NEAR DRYERS IN OPERATION.**

FOR YOUR SAFETY

DO NOT DRY MOP HEADS IN THE DRYER.

DO NOT USE DRYER IN THE PRESENCE OF DRY CLEANING FUMES.

WARNING

UNDER NO CIRCUMSTANCES should the dryer door switches, lint drawer switches, or heat safety circuit ever be disabled.

WARNING

The dryer *must never be* operated with any of the back guards, outer tops, or service panels removed. **PERSONAL INJURY OR FIRE COULD RESULT.**

WARNING

DRYER **MUST NEVER BE** OPERATED WITHOUT THE LINT FILTER/SCREEN IN PLACE, EVEN IF AN EXTERNAL LINT COLLECTION SYSTEM IS USED.

IMPORTANT

PLEASE OBSERVE **ALL SAFETY PRECAUTIONS** displayed on the equipment and/or specified in the installation manual included with the dryer.

Dryer *must not be* installed or stored in an area where it **will be** exposed to water or weather.

The wiring diagram for the dryer is located in the front electrical control box area.

IMPORTANT

Dryer *must be* installed in a location/environment, which the ambient temperature remains between 40° F (4.44° C) and 130° F (54.44° C).

Table of Contents

SECTION I	
SAFETY PRECAUTIONS	4
SECTION II	
SPECIFICATIONS	5
SECTION III	
INSTALLATION PROCEDURES	7
A. Unpacking/Setting Up	7
B. Location of the Dryer	8
C. Dryer Enclosure Requirements	8
D. Fresh Air Supply Requirements	9
E. Exhaust Requirements	10
F. Electrical Information	15
G. Gas Information	18
H. Preparation For Operation	21
I. Preoperational Tests	22
J. Shutdown Instructions	23
SECTION IV	
PREOPERATIONAL INSTRUCTIONS	24
A. Coin Mode	24
B. Free Mode	24
SECTION V	
SERVICE/PARTS INFORMATION	25
A. Service	25
B. Parts	25

SECTION VI

WARRANTY INFORMATION 26

- A. Returning Warranty Cards 26
- B. Warranty 26
- C. Returning Warranty Parts 26

SECTION VII

ROUTINE MAINTENANCE 28

- A. Cleaning 28
- B. Adjustments 29
- C. Lubrication 29

SECTION VIII

DATA LABEL INFORMATION 30

SECTION IX

**PROCEDURE FOR FUNCTIONAL CHECK OF REPLACEMENT
COMPONENTS 32**

SECTION I

SAFETY PRECAUTIONS

WARNING: For your safety, the information in this manual *must be* followed to minimize the risk of fire or explosion or to prevent property damage, personal injury, or loss of life.

WARNING: The dryer *must never be* operated with any of the back guards, outer tops, or service panels removed. **PERSONAL INJURY OR FIRE COULD RESULT.**

1. **DO NOT** store or use gasoline or other flammable vapors and liquids in the vicinity of this or any other appliance.
2. Purchaser/user should consult the local gas supplier for proper instructions to be followed in the event the user smells gas. The instructions **should be** posted in a prominent location.
3. WHAT TO DO IF YOU SMELL GAS:
 - a. **DO NOT** try to light any appliance.
 - b. **DO NOT** touch any electrical switch.
 - c. **DO NOT** use any phone in your building.
 - d. Clear the room, building, or area of **ALL** occupants.
 - e. Immediately call your gas supplier from a neighbor's phone. Follow the gas supplier's instructions.
 - f. If you **cannot** reach your gas supplier, call the fire department.
4. Installation and service **must be** performed by a qualified installer, service agency, or gas supplier.
5. Dryer(s) **must be** exhausted to the outdoors.
6. Although **ADC** produces a very versatile dryer, there are some articles that, due to fabric composition or cleaning method, **should not be** dried in it.

WARNING: Dry only water washed fabrics. **DO NOT** dry articles spotted or washed in dry cleaning solvents, a combustible detergent, or "all purpose" cleaner.
EXPLOSION COULD RESULT.

WARNING: **DO NOT** dry rags or articles coated or contaminated with gasoline, kerosene, oil, paint, or wax.
EXPLOSION COULD RESULT.

WARNING: **DO NOT** dry mop heads. Contamination by wax or flammable solvent will create a fire hazard.

WARNING: *DO NOT* use heat for drying articles that contain plastic, foam, sponge rubber, or similarly textured rubber materials. Drying in a heated basket (tumbler) may damage plastics or rubber and may be a fire hazard.

7. A program **should be** established for the inspection and cleaning of lint in the heating unit area, exhaust ductwork, and inside the dryer. The frequency of inspection and cleaning can best be determined from experience at each location.

WARNING: The collection of lint in the burner area and exhaust ductwork can create a potential fire hazard.

8. For personal safety, the dryer **must be** electrically grounded in accordance with local codes and/or the National Electrical Code ANSI/NFPA NO. 70-LATEST EDITION or in Canada, the Canadian Electrical Codes Parts 1 & 2 CSA C22.1-1990 or LATEST EDITION.

NOTE: Failure to electrically ground the dryer properly will VOID THE WARRANTY.

9. **UNDER NO CIRCUMSTANCES** should the dryer door switches, lint drawer switches, or heat safety circuit ever be disabled.

WARNING: **PERSONAL INJURY OR FIRE COULD RESULT** should the dryer door switch, lint door switch, or heat safety circuit ever be disabled.

10. This dryer is not to be used in the presence of dry cleaning solvents or fumes.
11. Remove articles from the dryer as soon as the drying cycle has been completed.

WARNING: Articles left in the dryer after the drying and cooling cycles have been completed can create a fire hazard.

12. **READ AND FOLLOW ALL CAUTION AND DIRECTION LABELS ATTACHED TO THE DRYER.**
13. For safety, proper operation, and optimum performance, the dryer **must not be** operated with a load less than sixty-six percent (66%), 39 lbs (17 kg) of its rated capacity.

WARNING: **YOU MUST DISCONNECT AND LOCK OUT THE ELECTRIC SUPPLY AND THE GAS SUPPLY BEFORE ANY COVERS OR GUARDS ARE REMOVED FROM THE MACHINE TO ALLOW ACCESS FOR CLEANING, ADJUSTING, INSTALLATION, OR TESTING OF ANY EQUIPMENT PER OSHA (Occupational Safety and Health Administration) STANDARDS.**

IMPORTANT: Dryer *must be* installed in a location/environment, which the ambient temperature remains between 40° F (4.44° C) and 130° F (54.44° C).

SECTION II

SPECIFICATIONS

MAXIMUM CAPACITY* (DRY WEIGHT)		60 lbs	27.2 kg
BASKET (TUMBLER) DIAMETER		30"	76.2 cm
BASKET (TUMBLER) DEPTH		26-1/8"	66.4 cm
BASKET (TUMBLER) MOTOR (2 PLACES)		1/4 hp	0.186 kW
BLOWER (FAN) MOTOR (2 PLACES)		1/4 hp	0.186 kW
DOOR OPENING (DIAMETER)		21-1/2"	54.6 cm
BASKET (TUMBLER) VOLUME (PER POCKET)		10.7 cu ft	0.304 cu m
DRYERS PER 20'/40' CONTAINER		11/22	
DRYERS PER 48'/53' TRUCK		27/30	
Gas	VOLTAGE AVAILABLE		120-240 / 1 ϕ / 2w / 60 Hz
	APPROX. NET WEIGHT		790 lbs 358.3 kg
	APPROX. SHIPPING WEIGHT		850 lbs 385.6 kg
	HEAT INPUT		176,000 Btu/hr 44,352 kcal/hr
	AIRFLOW (TOTAL BOTH BASKETS)		1,040 cfm 29.5 cmm
	INLET PIPE CONNECTION**		3/4" F.N.P.T.

Shaded areas are stated in metric equivalents.

12/16/03

* 30 lbs (13.6 kg) each pocket/tumbler.

** Size of piping varies with installation conditions. Contact factory for assistance.

NOTE: ADC reserves the right to make changes in specifications at any time without notice or obligation.

Specifications

DRYER NOTES:

- * DUCTWORK SIZE VARIES WITH INSTALLATION CONDITIONS.
- * EXHAUST STATIC PRESSURE MUST BE NO LESS THAN 0 AND MUST NOT EXCEED 0.3" (0.74 MB) WATER COLUMN.

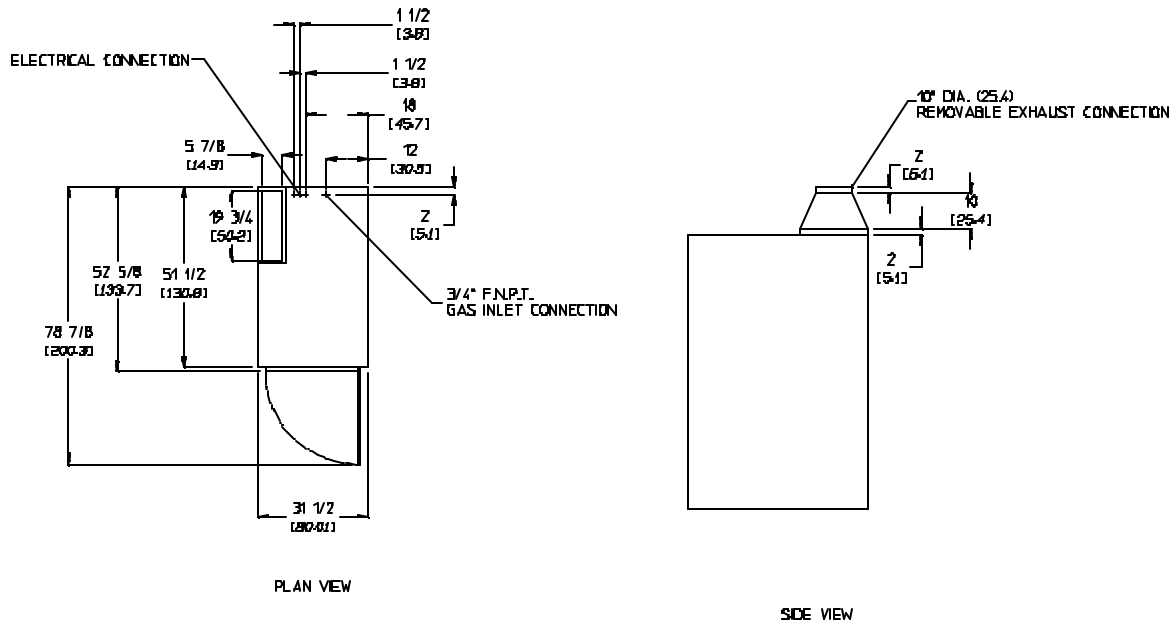

EV 7/2/03

NOTE: ADC reserves the right to make changes in specifications at any time without notice or obligation.

SECTION III

INSTALLATION PROCEDURES

Installation **should be** performed by competent technicians in accordance with local and state codes. In the absence of these codes, the installation **must conform** to applicable American National Standards: ANSI Z223.1-LATEST EDITION (National Fuel Gas Code) or ANSI/NFPA NO. 70-LATEST EDITION (National Electrical Code) or in Canada, the installation **must conform** to applicable Canadian Standards: CAN/CGA-B149.1-M91 (Natural Gas) or CAN/CGA-B149.2-M91 (Liquid Propane [L.P.] Gas) or LATEST EDITION (for General Installation and Gas Plumbing) or Canadian Electrical Codes Parts 1 & 2 CSA C22.1-1990 or LATEST EDITION (for Electrical Connections).

A. UNPACKING/SETTING UP

Remove protective shipping material (i.e., plastic wrap and/or optional shipping box) from dryer.

NOTE: The access keys for the service doors are included in the information packet shipped in the basket (tumbler). These keys **should be** removed and put in a safe place, yet made accessible because some **will be** needed throughout various phases in the installation of the dryer.

Dryers are shipped with a coin box and coin box faceplate ONLY. The coin box lock is not included and **must be** purchased elsewhere or the lock can be ordered as a parts order from the ADC factory.

IMPORTANT: For shipping purposes, the 10-inch (25.40 cm) exhaust adapter is shipped inside one (1) of the dryer's baskets (tumblers). This exhaust adapter **should either be** left inside the basket (tumbler) or removed and put in a safe place, and **must be** installed once the dryer is in place prior to making any exhaust duct connections.

The dryer can be moved to its final location while still attached to the skid or with the skid removed. With the skid removed, to make it easier to slide the dryer into its final position, slightly lower **ALL** four (4) leveling legs, so that the dryer will slide on the legs instead of the base frame. The dryer is equipped with four (4) leveling legs, one (1) at each corner of the dryer base. The legs can be adjusted by either tilting and properly supporting the dryer, and adjusting from underneath with an open end wrench (or adjustable wrench). Or, by removing the rear lower back panel and/or front lower service panel and adjusting the leveling leg with a 1/4" socket.

IMPORTANT: When tilting the dryer to adjust the leveling legs, be sure to properly support the bottom of the dryer with a block of wood or similar object. Failure to do so can cause personal injury.

B. LOCATION OF THE DRYER

Before installing the dryer, be sure the location conforms to local codes and ordinances. In the absence of such codes or ordinances the location **must conform** with the National Fuel Gas Code ANSI.Z223.1 LATEST EDITION, or in Canada, the installation **must conform** to applicable Canadian Standards: CAN/CGA-B149.1-M91 (Natural Gas) or CAN/CGA-B149.2-M91 (Liquid Propane [L.P.] Gas) or LATEST EDITION (for General Installation and Gas Plumbing).

1. The dryer **must be** installed on a sound level floor capable of supporting its weight. Carpeting **must be** removed from the floor area that the dryer is to rest on.

IMPORTANT: “The dryer **must be** installed on noncombustible floors only.”

2. Even though a 12-inch (30.48 cm) clearance is acceptable, it is recommended that the rear of the dryer be positioned approximately 2 feet (0.61 meters) away from the nearest obstruction, i.e., wall, for ease of installation, maintenance, and service.
3. The dryer **must be** installed with a proper exhaust duct connection to the outside.
4. The dryer **must be** installed with provisions for adequate combustion and make-up air supply.

CAUTION: This dryer produces combustible lint and **must be** exhausted to the outdoors. Every 6 months, inspect the exhaust ducting and remove any lint buildup.

IMPORTANT: Dryer **must be** installed in a location/environment, which the ambient temperature remains between 40° F (4.44° C) and 130° F (54.44° C).

C. DRYER ENCLOSURE REQUIREMENTS

Bulkheads and partitions **should be** made of noncombustible materials and **must be** located a minimum of 24-inches (60.96 cm) above the dryer outer top, except along the front of the dryer which may be closed in if desired.

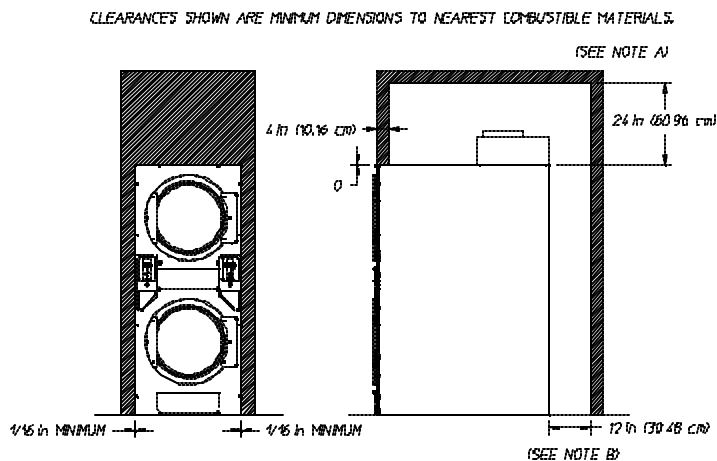

NOTES

A MINIMUM OF 24" (60.96 cm) CLEARANCE IS ACCEPTABLE FOR EASE OF INSTALLATION AND SERVICE (VENTING AND POWER CONNECTIONS)

B MINIMUM OF 12" (30.48 cm) CLEARANCE IS ACCEPTABLE FOR EASE OF INSTALLATION, MAINTENANCE AND SERVICE, AT LEAST 24" (60.96 cm) IS RECOMMENDED.

D. FRESH AIR SUPPLY REQUIREMENTS

Air supply (make-up air) **must be** given careful consideration to ensure proper performance of each dryer. An unrestricted source of 1,040 cfm (29.44 cmm) is necessary for each dryer (total for both baskets [tumblers]). An unrestricted air entrance from the outdoors (atmosphere) of a minimum of 1-1/2 square feet (0.14 square meters) is required for each dryer. This area **must be** enlarged if louvers or registers cover the opening. It is not necessary to have a separate make-up air opening for each dryer. Common make-up air openings are acceptable. However, they **must be** set up in such a manner that the make-up air is distributed equally to the dryers. For example, for a bank of eight (8) dryers, a total make-up air opening of 12 square feet (1.15 square meters) is required. Two (2) openings measuring 2 feet by 3 feet (0.61 meters by 0.91 meters) (6 square feet [0.58 square meters]) are acceptable. The dryer **must be** installed with provisions for adequate combustion and make-up air supply.

Allowances **must be** made for remote or constricting passageways or where dryers are located at excessive altitudes or predominantly low-pressure areas.

IMPORTANT: Make-up air **must be** provided from a source free of dry cleaning solvent fumes. Make-up air that is contaminated by dry cleaning solvent fumes will result in irreparable damage to the motors and other dryer components.

IMPORTANT: Make-up air openings **should not be** located near ductwork exhaust outlets. If make-up air openings are too close to the exhaust outlet, lint and fumes may be drawn back into the dryer area through these openings.

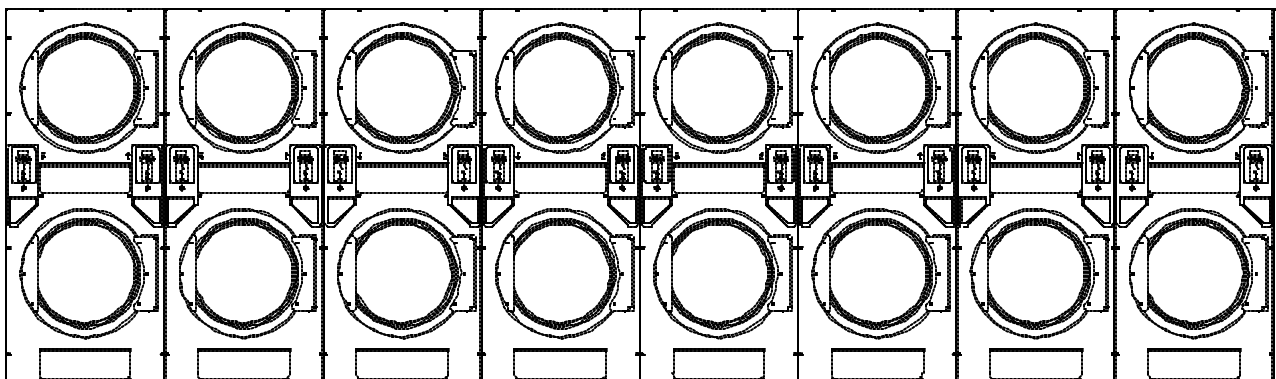
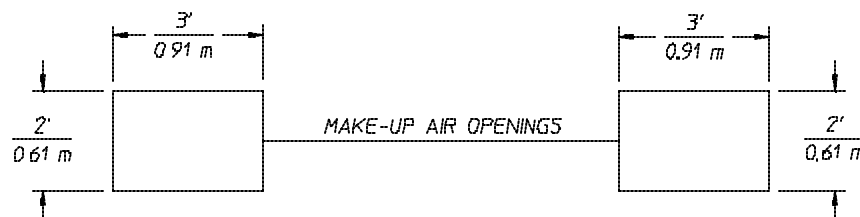

ABE 01/19/00

MAN4931

TYPICAL INSTALLATION SHOWING MAKE-UP AIR OPENINGS

NOTE: Component failure due to dry cleaning fumes will VOID THE WARRANTY.

E. EXHAUST REQUIREMENTS

Exhaust ductwork **should be** designed and installed by a qualified professional. Improperly sized ductwork will create excessive back pressure which will result in slow drying, increased use of energy, overheating of the dryer, and shutdown of the burner by the airflow (sail) switches, burner hi-limits, or basket (tumbler) hi-limit thermostats. The dryer **must be** installed with a proper exhaust duct connection to the outside.

CAUTION: This dryer produces combustible lint and *must be* exhausted to the outdoors.

When possible, it is suggested to provide a separate exhaust duct for each dryer.

CAUTION: IMPROPERLY SIZED OR INSTALLED EXHAUST DUCTWORK CAN CREATE A POTENTIAL FIRE HAZARD.

The exhaust ductwork **must be** laid out in such a way that the ductwork travels as directly as possible to the outdoors with as few turns as possible. The shape of the ductwork is not critical provided that the minimum cross-sectional area is maintained.

When single dryer venting is used, for horizontal or vertical venting the minimum duct size is 10-inches (25.40 cm) in diameter and the ductwork from the dryer to the outside exhaust outlet **must not exceed** a distance of 35 feet (10.67 meters) and have no more than two (2) elbows (including both connection to dryer and outside protection).

In the case of multiple (common) venting, using the applicable duct size (diameter) noted in this manual, for horizontal venting the distance from the last dryer to the outside outlet **must not exceed** 15 feet (4.57 meters) and have no more than one (1) elbow (including outside protection). In the case of common vertical venting, the distance from the last dryer to the outside outlet **must not exceed** 25 feet (7.62 meters) and have no more than three (3) elbows (including outside protection).

IMPORTANT: Exhaust back pressure measured by a manometer at the dryer exhaust duct area *must be* no less than 0 and *must not exceed* 0.3 inches (0.74 mb) of water column (W.C.).

It is suggested that the use of 90° turns in ducting be avoided; use 30° or 45° angles instead. The ductwork **should be** smooth inside with no projections from sheet metal screws or other obstructions, which will collect lint. When adding ducts, the duct to be added should overlap the duct to which it is to be connected. **ALL** ductwork joints **must be** taped to prevent moisture and lint from escaping into the building. Also, inspection doors **should be** installed at strategic points in the exhaust ductwork for periodic inspection and cleaning.

When the exhaust ductwork passes through a wall, ceiling, or roof made of combustible materials, the opening **must be** 2-inches (5.08 cm) larger than the duct (all the way around). The duct **must be** centered within this opening.

If the ductwork run (distance) or the amount of elbows required exceeds the limits noted in this manual, the size (diameter/cross-sectional area) of the ductwork **must be** increased in proportion to the length or number of elbows added. When the ductwork approaches the maximum limits as noted in this manual, a professional heating, ventilating, and air-conditioning (HVAC) firm **must be** consulted for proper venting information.

1. Dryer exhaust connection. The dryer is shipped with a 10-inch (25.40 cm) exhaust adapter, which for shipping purposes is shipped inside of the dryer's basket (tumbler). This exhaust adapter **must be** installed (with screws provided) once the dryer is in place prior to making any exhaust connections.

IMPORTANT: Minimum duct size for dryer is 10-inches (25.40 cm) round duct. Duct size *must not be* reduced anywhere downstream of dryer.

IMPORTANT: It is recommended that exhaust or booster fans not be used in the exhaust ductwork system.

NOTE: As per the National Fuel Gas Code, “Exhaust ducts for type 2 clothes dryers shall be constructed of sheet metal or other noncombustible material. Such ducts shall be equivalent in strength and corrosion resistance to ducts made of galvanized sheet steel not less than 0.0195-inches (26 gauge [0.05 mm]) thick.”

2. Venting Layout

a. Single Dryer Venting

When single dryer venting is used, for horizontal or vertical venting the minimum duct size is 10-inches (25.40 cm) in diameter and the ductwork from the dryer to the outside exhaust outlet **must not exceed** a distance and the number of elbows (including both connection to dryer and outside protection shown in the **illustration below**).

IMPORTANT: Exhaust back pressure measured by a manometer at the dryer exhaust duct area *must be* no less than 0 and *must not exceed* 0.3 inches (0.74 mb) of water column (W.C.).

CAUTION: IMPROPERLY SIZED OR INSTALLED EXHAUST DUCTWORK CAN CREATE A POTENTIAL FIRE HAZARD.

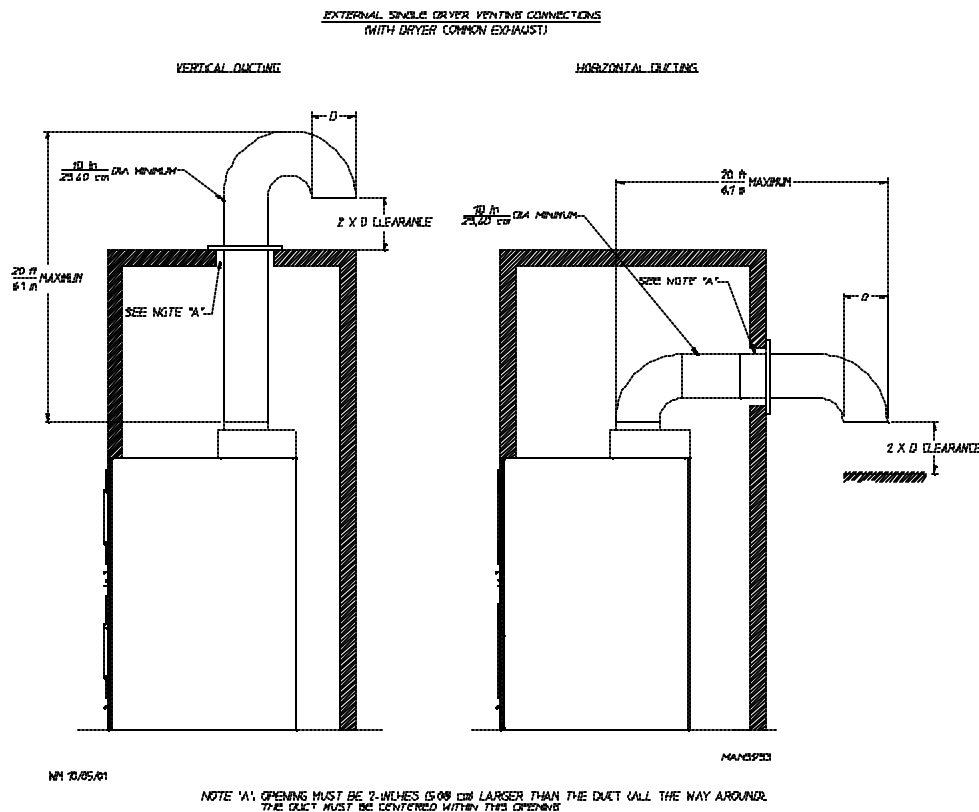

It is suggested that the use of 90° turns in ducting be avoided; use 30° or 45° angles instead. The ductwork **should be** smooth inside with no projections from sheet metal screws or other obstructions, which will collect lint. When adding ducts, the duct to be added should overlap the duct to which it is to be connected. **ALL** ductwork joints **must be** taped to prevent moisture and lint from escaping into the building. Also, inspection doors **should be** installed at strategic points in the exhaust ductwork for periodic inspection and cleaning.

IMPORTANT: Minimum duct size for dryer is 10-inches (25.40 cm) round duct. Duct size **must not be** reduced anywhere downstream of dryer.

When the exhaust ductwork passes through a wall, ceiling, or roof made of combustible materials, the opening **must be** 2-inches (5.08 cm) larger than the duct (all the way around). The duct **must be** centered within this opening.

IMPORTANT: If the ductwork run (distance) or the amount of elbows required exceeds the limits noted in this manual, the size (diameter/cross-sectional area) of the ductwork can only be increased to an extent. When the ductwork approaches the maximum limits as noted in this manual, a professional heating, ventilating, and air-conditioning (HVAC) firm **must be** consulted for proper venting information.

b. Common Venting

If it is not feasible to provide separate exhaust ducts for each dryer, ducts from individual dryers may be channeled into a “common main duct.” The individual ducts should enter the bottom or the side of the main common duct at an angle not more than 45° in the direction of airflow. The main duct **should be** tapered, with the diameter increasing before each individual duct 10-inches (25.40 cm) is added.

IMPORTANT: No more than four (4) dryers or eight (8) pockets total **should be** connected to one (1) common duct.

Minimum duct size between dryer and common duct is 10-inches (25.40 cm) in diameter. This duct must not travel more than 15 feet (4.57 meters) and include no more than three (3) elbows (which includes both dryer and common duct connections).

NOTE: Refer to **illustrations** on **page 13 and page 14** for examples of multiple dryer (common) venting.

In the case of multiple (common) venting, using the applicable duct size (diameter) noted in this manual, for horizontal venting the distance from the last dryer to the outside outlet **must not exceed** 15 feet (4.57 meters) and have no more than one (1) elbow (including outside protection). In the case of common vertical venting, the distance from the last dryer to the outside outlet **must not exceed** 25 feet (7.62 meters) and have no more than three (3) elbows (including outside protection).

IMPORTANT: Exhaust back pressure measured by a manometer at the dryer exhaust duct area **must be** no less than 0 and **must not exceed** 0.3 inches (0.74 mb) of water column (W.C.).

CAUTION: IMPROPERLY SIZED OR INSTALLED EXHAUST DUCTWORK CAN CREATE A POTENTIAL FIRE HAZARD.

It is suggested that the use of 90° turns in ducting be avoided; use 30° or 45° angles instead. The ductwork **should be** smooth inside with no projections from sheet metal screws or other obstructions, which will collect lint. When adding ducts, the duct to be added should overlap the duct to which it is to be connected. **ALL** ductwork joints **must be** taped to prevent moisture and lint from escaping into the building. Also, inspection doors **should be** installed at strategic points in the exhaust ductwork for periodic inspection and cleaning.

When the exhaust ductwork passes through a wall, ceiling, or roof made of combustible materials, the opening **must be** 2-inches (5.08 cm) larger than the duct (all the way around). The duct **must be** centered within this opening.

IMPORTANT: If the ductwork run (distance) or the amount of elbows required exceeds the limits noted in this manual, the size (diameter/cross-sectional area) of the ductwork can only be increased to an extent. When the ductwork approaches the maximum limits as noted in this manual, a professional heating, ventilating, and air-conditioning (HVAC) firm **must be** consulted for proper venting information.

MULTIPLE DRYER VENTING
WITH 10" (25.40 CM) DIAMETER EXHAUST CONNECTIONS AT COMMON DUCT

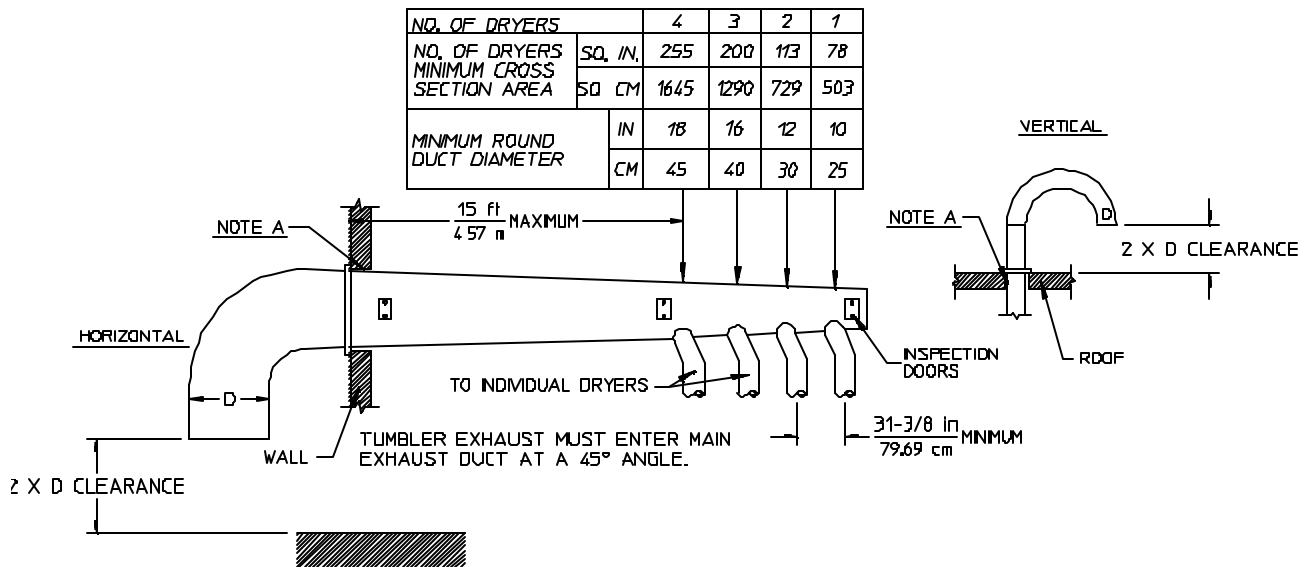

IMPORTANT: NO MORE THAN 4 DRYERS (8 TUMBLERS) CAN BE CONNECTED TO ONE COMMON DUCT (VENT)

JEV 08/27/01

MAN5849

FORMULAS TO CALCULATE DUCTING CROSS SECTIONAL AREA

CROSS SECTIONAL AREA OF A ROUND DUCT = .785 (19.939 MM) × D² WHERE D = DIAMETER OF THE DUCT.

CROSS SECTIONAL AREA OF A RECTANGULAR DUCT = W × H WHERE W = WIDTH AND H = HEIGHT

NOTE A: OPENING MUST BE 2-INCHES (5.08 CM) LARGER THAN THE DUCT (ALL THE WAY AROUND) THE DUCT MUST BE CENTERED WITHIN THIS OPENING.

MULTIPLE DRYER VENTING (VERTICAL) WITH A
MINIMUM 10" (25.40 cm) DIAMETER EXHAUST CONNECTIONS AT COMMON DUCT

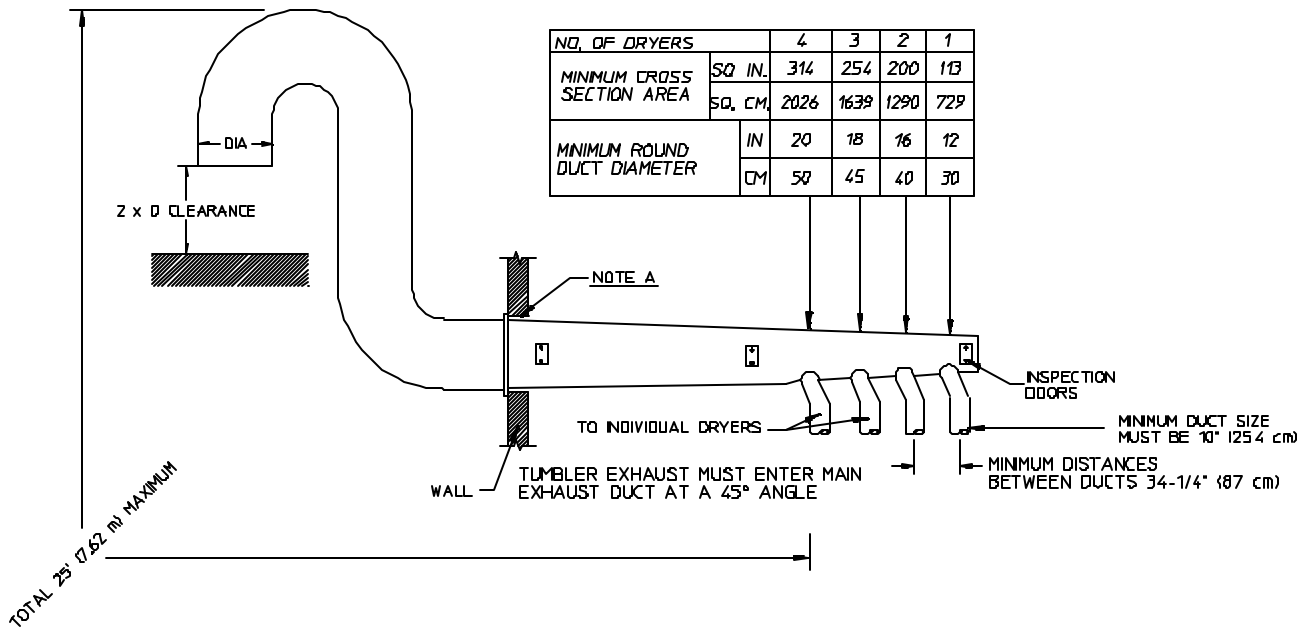

IMPORTANT: NO MORE THAN 4 DRYERS (8 TUMBLERS) CAN BE CONNECTED TO ONE COMMON DUCT (VENT).

MAN5851

FORMULAS TO CALCULATE DUCTING CROSS SECTIONAL AREA

CROSS SECTIONAL AREA OF A ROUND DUCT = .785 (19.939 MM) x DIA²

CROSS SECTIONAL AREA OF A RECTANGULAR DUCT = WIDTH x HEIGHT

JEV 08/21/01

NOTE A: OPENING MUST BE 2-INCHES (5.08 cm) LARGER THAN THE DUCT (ALL THE WAY AROUND). THE DUCT MUST BE CENTERED WITHIN THIS OPENING.

c. Outside Ductwork (Vent) Protection

To protect the outside end of the horizontal ductwork from the weather, a 90° elbow turned downward **should be** installed where the exhaust duct exits the building. If the ductwork travels vertically up through a roof, it **should be** protected from the weather by using a 180° turn (goose neck) to point the opening downward. In either case, allow at least twice the diameter of the duct between the duct opening and the nearest obstruction.

IMPORTANT: DO NOT use screens, louvers, or caps on the outside opening of the exhaust ductwork.

VERTICAL DUCTING

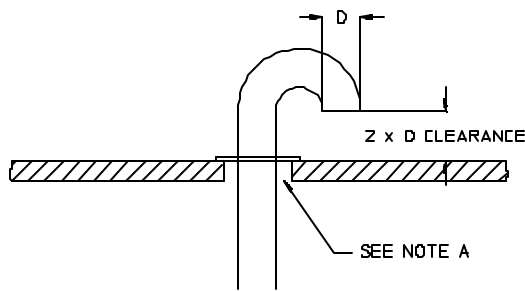

MAN4589

NOTE "A" OPENING MUST BE TWO (2) INCHES (5.08 CM) LARGER THAN DUCT (ALL THE WAY AROUND). THE DUCT MUST BE CENTERED WITHIN THIS OPENING.

HORIZONTAL DUCTING

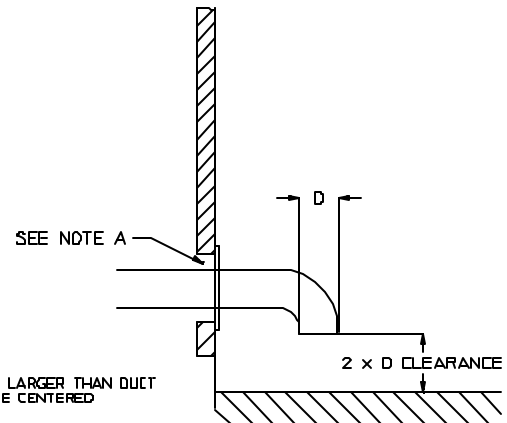

When the exhaust ductwork passes through a wall, ceiling, or roof made of combustible materials, the opening **must be** 2-inches (5.08 cm) larger than the duct (all the way around). The duct **must be** centered within this opening.

F. ELECTRICAL INFORMATION

1. Electrical Requirements

It is your responsibility to have **ALL** electrical connections made by a properly licensed and competent electrician to ensure that the electrical installation is adequate and conforms to local and state regulations or codes. In the absence of such codes, **ALL** electrical connections, materials, and workmanship **must conform** to the applicable requirements of the National Electrical Code ANSI/NFPA NO. 70-LATEST EDITION or in Canada, the Canadian Electrical Codes Parts 1 & 2 CSA C22.1-1990 or LATEST EDITION.

IMPORTANT: Failure to comply with these codes or ordinances, and/or the requirements stipulated in this manual, can result in **PERSONAL INJURY OR COMPONENT FAILURE**.

NOTE: Component failure due to improper installation will **VOID THE WARRANTY**.

A separate circuit servicing each basket (tumbler) **must be** provided. The dryer **must be** connected to copper wire **ONLY**. **DO NOT use aluminum wire, it could create a fire hazard.**

NOTE: The use of aluminum wire will **VOID THE WARRANTY**.

2. Electrical Connections

A wire diagram is included with each dryer showing the wiring connection sequence. The electrical connections are made in the wiring box located at the rear top area of the dryer.

Each pocket **must be** provided with a separate circuit. The external power connection for the top pocket is made to a terminal block and the lower external power connection is made to a wire harness, both are located in the above mentioned wire box.

If local codes permit, power to the dryer can be made by the use of a flexible U.L. listed power cord/pigtail (wire size **must conform** to rating of dryer), or the dryer can be hard wired directly to the service breaker panel. In both cases, a strain relief **must be** installed where the wiring enters the dryer.

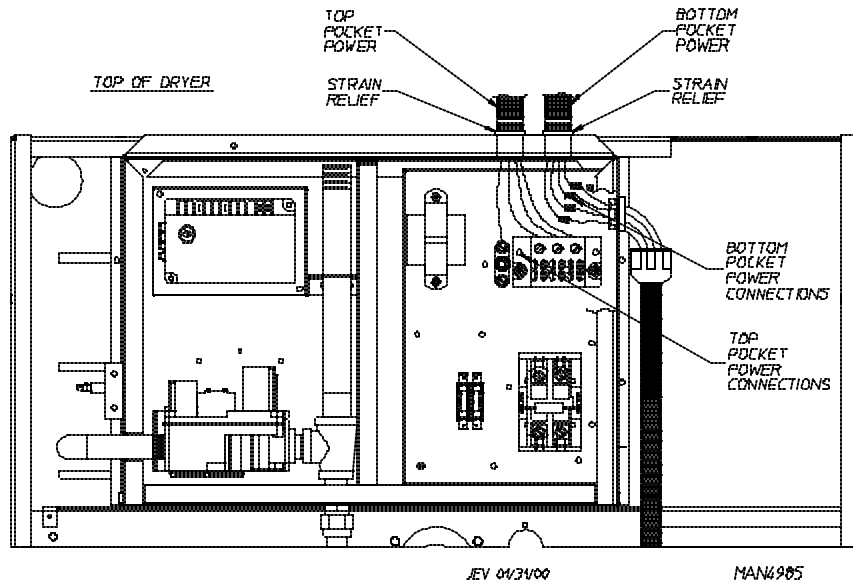

Electrical power connection examples:

IMPORTANT: For a 120v installation, a 2-wire service (L1 and Neutral) and a ground is required for each basket (tumbler)/pocket. In the case of a 208v or 230/240v 1-phase (1 ϕ) service, 3-wires (L1, L2 and Neutral) and a ground is required for each basket (tumbler)/pocket.

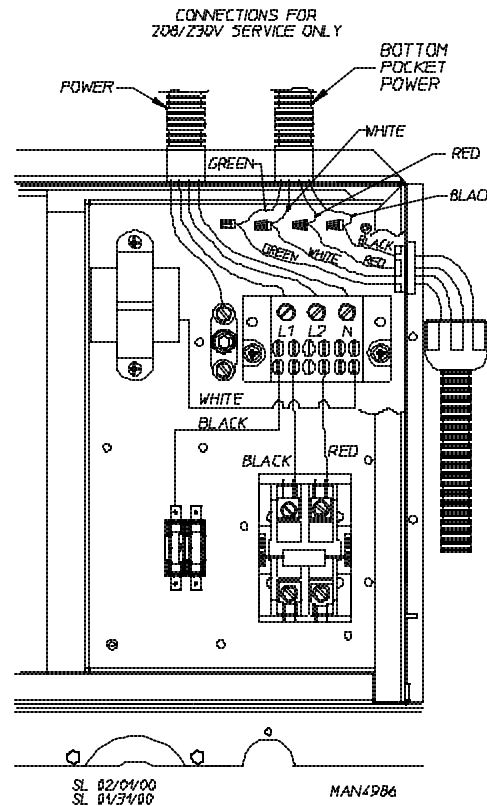
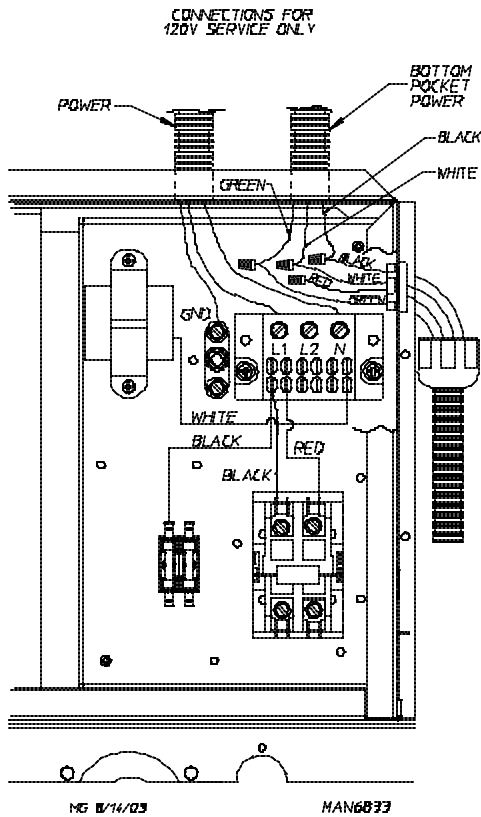

3. Grounding

A ground (earth) connection **must be** provided and installed in accordance with state and local codes. In the absence of these codes, grounding **must conform** to applicable requirements of the National Electrical Code ANSI/NFPA NO. 70-LATEST EDITION, or in Canada, the installation **must conform** to applicable Canada Standards: Canadian Electrical Codes Parts 1 & 2 CSA C22.1-1990 or LATEST EDITION. The ground connection may be to a proven earth ground at the location service panel.

For added personal safety, when possible, it is suggested that a separate ground wire (sized per local codes) be connected from the ground connection of the dryer to a grounded cold water pipe. **DO NOT ground to a gas pipe or hot water pipe.** The grounded cold water pipe must have metal to metal connections **ALL** the way to the electrical ground. If there are any nonmetallic interruptions, such as, a meter, pump, plastic, rubber, or other insulating connectors, they **must be** jumped out with no. 4 wire and securely clamped to bare metal at both ends.

IMPORTANT: For personal safety and proper operation, the dryer **must be** grounded.

4. Electrical Service Specifications (per pocket)

IMPORTANT: The dryer **must be** connected to the electrical supply shown on the dryer data label.

WARNING: Any damage done to dryer components due to improper voltage application or connections will automatically **VOID THE WARRANTY.**

GAS					
ELECTRICAL SERVICE SPECIFICATIONS (PER DRYER)					
IMPORTANT: 208 VAC AND 230/240 VAC ARE NOT THE SAME. When ordering, <i>specify exact voltage.</i>					
NOTES:					
A. When fuses are used they must be dual element, time delay, current limiting, class RK1 or RK5 ONLY. Calculate/determine correct fuse value, by applying either local and/or National Electrical Codes to listed appliance amp draw data.					
B. Circuit breakers are thermal-magnetic (industrial) motor curve type ONLY. For others, calculate/verify correct breaker size according to appliance amp draw rating and type of breaker used.					
SERVICE VOLTAGE	PHASE	WIRE SERVICE	APPROX. AMP DRAW	MINIMUM WIRE SIZE	CIRCUIT BREAKER
			60 Hz		
120	1∅	2	9.7	*	15
208	1∅	2	5.4	*	15
230/240	1∅	2	5.4	*	15

*AWG Stranded Wire Type - size wire as per National Electrical Code or local codes.

12/17/03

NOTE: Contact factory for electrical information not listed.

NOTE: ADC reserves the right to make changes in specifications at any time without notice or obligation.

G. GAS INFORMATION

It is your responsibility to have **ALL** plumbing connections made by a qualified professional to ensure that the gas plumbing installation is adequate and conforms to local and state regulations or codes. In the absence of such codes, **ALL** plumbing connections, materials, and workmanship **must conform** to the applicable requirements of the National Fuel Gas Code ANSI Z223.1-LATEST EDITION, or in Canada, the Canadian Installation Codes CAN/CGA-B149.1-M91 (Natural Gas) or CAN/CGA-B149.2-M91 (Liquid Propane [L.P.] Gas) or LATEST EDITION.

IMPORTANT: Failure to comply with these codes or ordinances, and/or the requirements stipulated in this manual, can result in personal injury and improper operation of the dryer.

The dryer and its individual shutoff valve **must be** disconnected from the gas supply piping system during any pressure testing of that system at test pressures in excess of 1/2 psig (3.5 kPa).

The dryer **must be** isolated from the gas supply piping system by closing its individual manual shutoff valve during any pressure test of the gas supply system at test pressures equal to or less than 1/2 psig (3.5 kPa).

IMPORTANT: Failure to isolate or disconnect the dryer from supply as noted can cause irreparable damage to the gas valve VOIDING THE WARRANTY.

WARNING: FIRE OR EXPLOSION COULD RESULT due to failure of isolating or disconnecting the gas supply as noted.

1. Gas Supply

The gas dryer installation **must meet** the American National Standard...National Fuel Gas Code ANSI Z223.1-LATEST EDITION, or in Canada, the Canadian Installation Codes CAN/CGA-B149.1 M91 (Natural Gas) or CAN/CGA-B149.2-M91 (L.P. Gas) or LATEST EDITION, as well as local codes and ordinances and **must be** done by a qualified professional.

NOTE: Undersized gas piping will result in ignition problems, slow drying, increased use of energy, and can create a safety hazard.

The dryer **must be** connected to the type of heat/gas indicated on the dryer data label. If this information does not agree with the type of gas available, contact the reseller who sold the dryer or contact the **ADC** factory.

IMPORTANT: Any burner changes or conversions **must be** made by a qualified professional.

The input ratings shown on the dryer data label are for elevations up to 2,000 feet (609.6 meters), unless elevation requirements of over 2,000 feet (609.6 meters) were specified at the time the dryer order was placed with the factory. The adjustment or conversion of dryers in the field for elevations over 2,000 feet (609.6 meters) is made by changing each burner orifice. If this conversion is necessary, contact the reseller who sold the dryer or contact the **ADC** factory.

IMPORTANT: THIS GAS DRYER **IS NOT** PROVIDED WITH AN INTERNAL GAS SUPPLY SHUTOFF AND AN EXTERNAL GAS SUPPLY SHUTOFF **MUST BE** PROVIDED.

2. Technical Gas Data

a. Gas Specifications

TYPE OF GAS				
	NATURAL		LIQUID PROPANE	
Manifold Pressure*	3.5 inches W.C.	8.7 mb	10.5 inches W.C.	26.1 mb
In-Line Pressure	6.0 - 12.0 inches W.C.	14.92 - 29.9 mb	11.0 inches W.C.	27.4 mb

Shaded areas are stated in metric equivalents

* Measured at gas valve pressure tap when the gas valve is on.

GAS INLET SIZE (EACH BASKET/TUMBLER)	3/4" N.P.T.	
INPUT (EACH BASKET/TUMBLER)	90,000 BTU/HR	22,680 kcal/hr
INPUT (TOTAL FOR BOTH BASKETS/TUMBLERS)	180,000 BTU/HR	45,360 kcal/hr

N.P.T. = National Pipe Thread

b. Natural Gas

Regulation is controlled by each dryer's gas valve's internal regulator. Incoming supply pressure **must be** consistent between a minimum of 6.0 inches (14.92 mb) and a maximum of 12.0 inches (29.9 mb) water column (W.C.) pressure.

c. Liquid Propane (L.P.) Gas

Dryers made for use with L.P. gas have the gas valve's internal pressure regulator blocked open so that the gas pressure **must be** regulated upstream of the dryer. The pressure measured at each gas valve pressure tap **must be** a consistent 10.5 inches (26.1 mb) water column. There is no regulator or regulation provided in an L.P. dryer. The water column pressure **must be** regulated at the source (L.P. tank) or an external regulator **must be** added to each dryer.

3. Piping Connections

ALL components/materials **must conform** to National Fuel Gas Code Specifications ANSI Z223.1-LATEST EDITION, or in Canada, CAN/CGA-B149.1-M91 (Natural Gas) or CAN/CGA-B149.2-M91 (L.P. Gas) or LATEST EDITION (for General Installation and Gas Plumbing), as well as local codes and ordinances and **must be** done by a qualified professional. It is important that gas pressure regulators meet applicable pressure requirements, and that gas meters be rated for the total amount of **ALL** the appliance Btus being supplied.

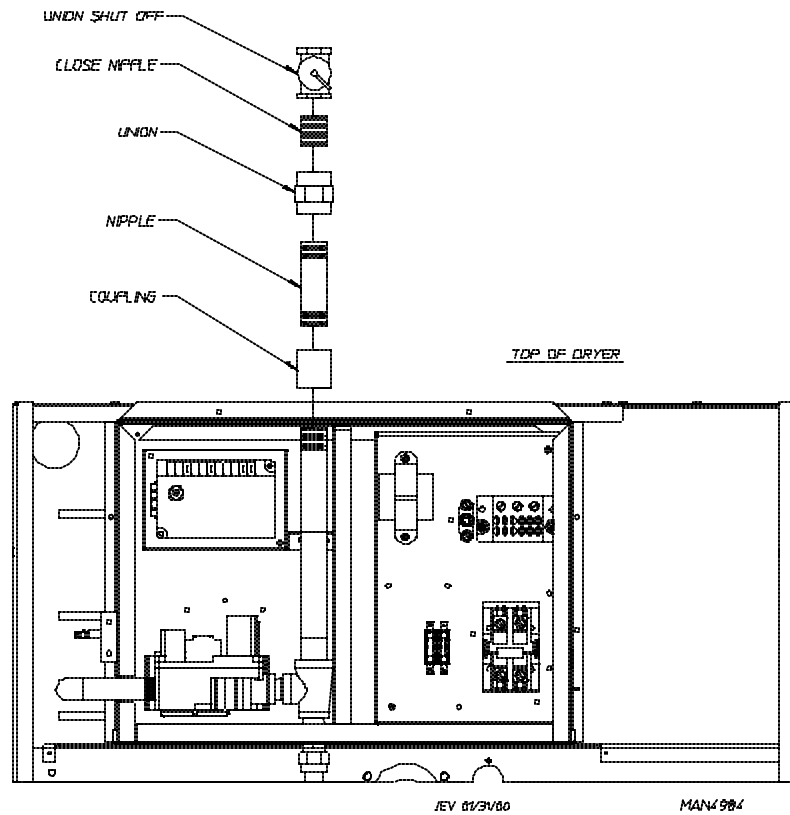

The size of the main gas supply line (header) will vary depending on the distance this line travels from the gas meter (or in the case of liquid propane [L.P.] gas, the supply tank), the number of tees, other gas-operated appliances on the supply line, etc. Specific information regarding supply line size **should be** determined by the gas supplier.

NOTE: Undersized gas supply piping can create a low or inconsistent pressure which will result in erratic operation of the burner ignition system.

Consistent gas pressure is essential at **ALL** gas connections. It is recommended that a 3/4" (19.05 mm) pipe loop be installed in the supply line servicing the bank of dryers. An in-line pressure regulator **must be** installed in the gas supply line (header) if (natural) gas line pressure exceeds 12.0 inches (29.9 mb) water column (W.C.) pressure. (Refer to the **illustrations** on **page 21** for details.)

IMPORTANT: Water column pressure of 3.5 inches (8.7 mb) for natural gas dryers and 10.5 inches (26.1 mb) for L.P. gas is required at the gas valve pressure tap of each dryer for proper and safe operation.

A 1/8" N.P.T. plugged tap, accessible for a test gauge connection, **must be** installed in the main gas supply line immediately upstream of each dryer.

IMPORTANT: Pipe joint compounds that resist the action of natural gas and L.P. gas **must be** used.

WARNING: Test **ALL** connections for leaks by brushing on a soapy water solution (liquid detergent also works well).

WARNING: **NEVER TEST FOR LEAKS WITH A FLAME!!!**

TYPICAL NATURAL GAS INSTALLATION

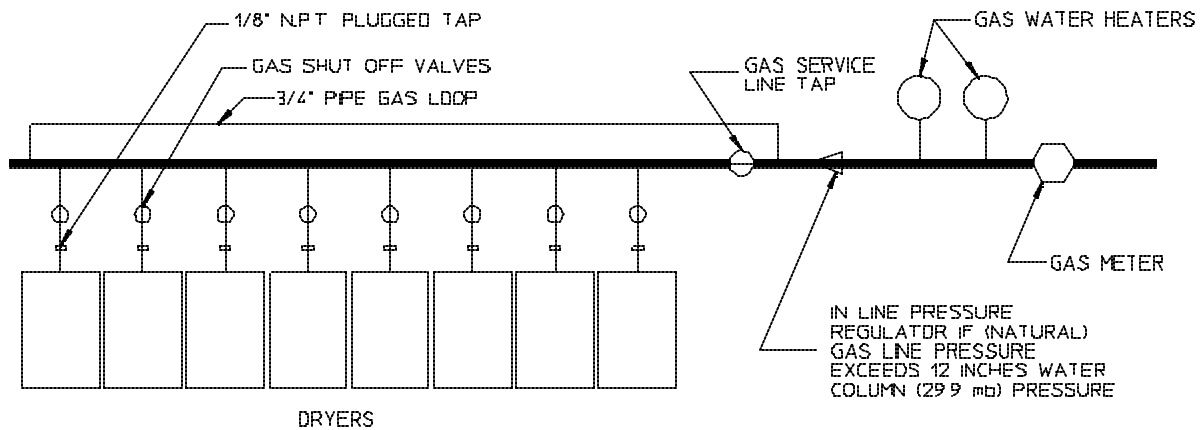

TYPICAL LP GAS INSTALLATION

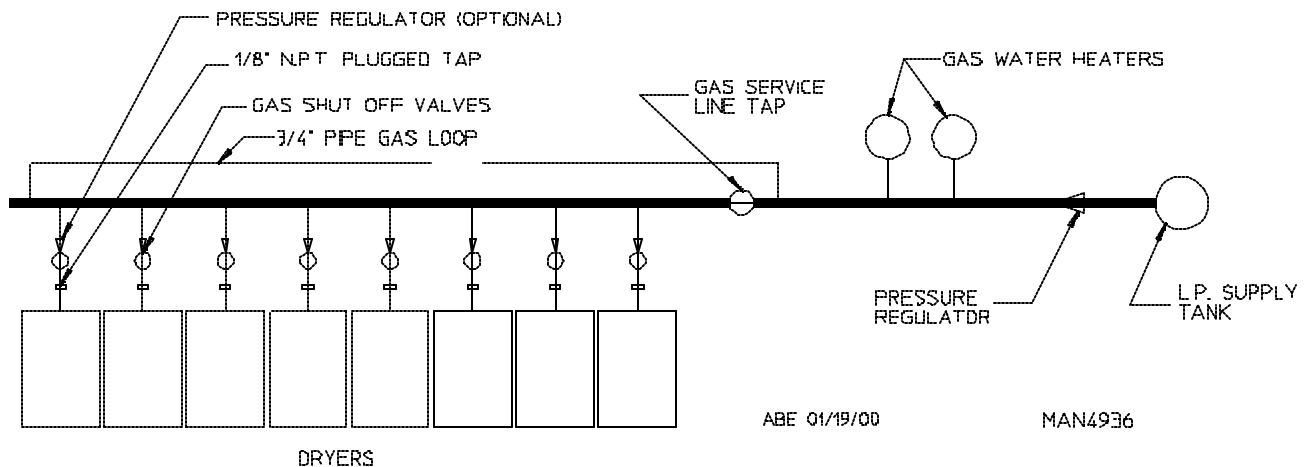

ABE 01/19/00

MAN4936

H. PREPARATION FOR OPERATION

The following items **should be** checked before attempting to operate the dryer:

1. Read **ALL** “CAUTION,” “WARNING,” and “DIRECTION” labels attached to the dryer.
2. Check incoming supply voltage to be sure that it is the same as indicated on the dryer data label.
3. Check to ensure that the dryer is connected to the type of heat/gas indicated on the dryer data label.
4. The sail switch damper assembly was installed and adjusted at the factory prior to shipping. However, each sail switch adjustment **must be** checked to ensure that this important safety control is functioning.
5. Check bolts, nuts, screws, terminals, and fittings for tightness.

6. Be sure that **ALL** gas shutoff valves are in the open position.
7. Be sure **ALL** back guard panels and service box covers have been replaced.
8. Check the lint drawer to ensure that it is closed and secured in place.
9. Rotate the basket (tumbler) by hand to be sure they move freely.

I. PREOPERATIONAL TESTS

ALL dryers are thoroughly tested and inspected before leaving the factory. However, a preoperational test **should be** performed before the dryer is publicly used. It is possible that adjustments have changed in transit.

1. Turn on electric power to the dryer.

Open **ALL** gas shutoff valves.

2. Computer System Operational Test

Coin Models / Non-Coin (Free Mode)

- a. The liquid crystal display (L.C.D.) display(s) will display “READY, AMOUNT TO START” and the amount needed to start the dryer (i.e., “25”), meaning that the dryer is available and 25¢ is required to start it.
- b. Insert the proper number of coins into coin acceptor. Once the correct amount needed to start the dryer has been inserted, the L.C.D. display(s) will read “SELECT TEMPERATURE”.
- c. Select temperature by pressing “HI”, “MED”, or “LO”. The cycle will start and the L.C.D. will display the dry cycle selected and remaining time.

NOTE: The dryer can be stopped at any time by opening the main door. To restart the dryer, shut the main door and press the desired setting.

NOTE: Selection (setting) changes can be made at any time during the drying cycle by opening and closing the main door and then making a new selection.

3. Heat Circuit Operational Test

- a. When a gas dryer is first started (during initial start-up), it has a tendency not to ignite on the first ignition attempt. This is because the gas supply piping is filled with air, so it may take a few minutes for the air to be purged from the lines.

The dryer is equipped with a Direct Spark Ignition (DSI) system, which has internal diagnostics. If ignition is not established, the heat circuit DSI module will lock out until it is manually reset. To reset the DSI system, open and close main door and restart dryer (press desired temperature selection).

NOTE: During the purging period, check to be sure that **ALL** gas shutoff valves are open.

- b. Once ignition is established, a gas pressure test **should be** taken at the gas valve pressure tap of each dryer to ensure that the water column (W.C.) pressure is correct and consistent.

NOTE: Water column pressure requirements (measured at the gas valve pressure tap):

Natural Gas 3.5 Inches (8.7 mb) Water Column.
Liquid Propane (L.P.) Gas 10.5 Inches (26.1 mb) Water Column.

IMPORTANT: **THERE IS NO REGULATOR PROVIDED IN AN L.P. DRYER.** The water column pressure **must be** regulated at the source (L.P. tank) or an external regulator **must be** added to each dryer.

4. Make a complete operational check of **ALL** safety related circuits (i.e., lint basket switches and sail switches).
5. Each basket (tumbler) **should be** operated through one (1) complete cycle to ensure that no further adjustments are necessary and that **ALL** components are functioning properly.

NOTE: The sail switch can be checked for proper operation by opening the control door while the dryer is running and the heating unit (burner) active (on). The heating unit(s) should shut off within a few seconds. If not, make the necessary adjustments.

BASKET (TUMBLER) COATING

The basket (tumbler) is treated with a protective coating. We suggest dampening old garments or cloth material with a solution of water and nonflammable mild detergent and tumbling them in the basket (tumbler) to remove this coating.

NOTE: When the drying and cooling cycles are complete, the light emitting diode (L.E.D.) display reads “donE.”

6. Computer Programs/Selections:

Each microprocessor controller (computer) has been preprogrammed by the factory with the most commonly used program (parameter) selections. If microprocessor controller (computer) program changes are required refer to the **Microprocessor Controller Programming Manual**, which was shipped with the dryer.

J. SHUTDOWN INSTRUCTIONS

In the case where the dryer is to be shutdown (taken out of service) for a period of time, the following **must be** performed:

1. Discontinue power to the dryer (both baskets [tumblers]) either at the external disconnect switch or the circuit breaker.
2. Discontinue the gas supply:

SHUT OFF external gas supply shutoff valve.

SECTION IV

PREOPERATIONAL INSTRUCTIONS

A. COIN MODE

1. When the controller is in the ready state and no cycle is in progress, the liquid crystal display (L.C.D.) screen will display either “READY, INSERT AMOUNT TO START” or “READY, INSERT \$XX.XX TO START.”
2. Insert coin(s). Once the correct AMOUNT TO START has been inserted, the L.C.D. will display “SELECT TEMPERATURE.”
3. Select temperature by pressing “HI”, “MED”, or “LO”. The cycle will start, and the L.C.D. will display the Dry Cycle selected and the remaining time.
4. The dryer will continue through the drying and cooling cycles, until the vended time has expired.
5. In Coin Mode, if more time is desired the customer will have to insert more credit. The dryer can be stopped by pressing the “PAUSE” key or opening the main door. Press either “HI”, “MED”, or “LO” key after pressing the “PAUSE” key or closing the main door to restart the dryer.
6. Upon completion of drying and cooling cycles the buzzer will sound, and the dryer will go into Wrinkle Guard Mode for 99 minutes or until the door has been opened.

B. FREE MODE

1. When the controller is in the ready state and no cycle is in progress, the L.C.D. screen will display “SELECT TEMPERATURE.”
2. Select temperature by pressing “HI”, “MED”, or “LO”. The cycle will start and the controller will display the Dry Cycle selected and the remaining time.
3. The dryer will continue through the drying and cooling cycles, until the drying time has expired.
4. In Free Mode, if more or less time is desired in a cycle press and hold either the “HI” key or “LO” key for 3-seconds. The control will now display the remaining time in the cycle. Pressing the “HI” key will increase the number of minutes remaining. Pressing the “LO” key will decrease the number of minutes remaining. The dryer can be stopped by pressing the “PAUSE” key or opening the main door. Press either “HI”, “MED”, or “LO” key after pressing the “PAUSE” key or closing the main door to restart the dryer.
5. Upon completion of the drying and cooling cycles, the buzzer will sound, and the dryer will go into Wrinkle Guard Mode for 99 minutes or until the door has been opened.

SECTION V

SERVICE/PARTS INFORMATION

A. SERVICE

Service **must be** performed by a qualified trained technician, service agency, or gas supplier. If service is required, contact the reseller from whom the **ADC** equipment was purchased. If the reseller **cannot** be contacted or is unknown, contact the **ADC** Service Department for a reseller in your area.

NOTE: When contacting the **ADC** Service Department, be sure to give them the correct **model number** and **serial number** so that your inquiry is handled in an expeditious manner.

B. PARTS

Replacement parts **should be** purchased from the reseller from whom the **ADC** equipment was purchased. If the reseller **cannot** be contacted or is unknown, contact the **ADC** Parts Department for a reseller in your area. Parts may also be purchased directly from the factory by calling the **ADC** Parts Department at (508) 678-9000 or you may FAX in your order at (508) 678-9447.

NOTE: When ordering replacement parts from the **ADC** reseller or the **ADC** factory be sure to give them the correct **model number** and **serial number** so that your parts order can be processed in an expeditious manner.

SECTION VI

WARRANTY INFORMATION

A. RETURNING WARRANTY CARDS

Before any dryer leaves the **ADC** factory test area, a warranty card is placed on the back side of the main door glass. These warranty cards are intended to serve the customer where we record the individual installation date and warranty information to better serve you should you file a warranty claim.

If a warranty card did not come with your dryer, contact the **ADC** Warranty Department or the **ADC** Service Department at (508) 678-9000.

IMPORTANT: A separate warranty card *must be* completed and returned for each individual dryer.

NOTE: Be sure to include the installation date when returning the warranty card(s).

B. WARRANTY

For a copy of the **ADC** commercial warranty covering your particular dryer(s), contact the **ADC** reseller from whom you purchased the equipment and request a dryer warranty form. If the reseller **cannot** be contacted or is unknown, warranty information can be obtained from the factory by contacting the **ADC** Warranty Department at (508) 678-9000.

NOTE: Whenever contacting the **ADC** factory for warranty information, be sure to have the dryer's **model number** and **serial number** available so that your inquiry can be handled in an expeditious manner.

C. RETURNING WARRANTY PARTS

ALL dryer or parts warranty claims or inquiries **should be** addressed to the **ADC** Warranty Parts Department. To expedite processing, the following procedures **must be** followed:

1. No parts are to be returned to **ADC** without prior written authorization (“Return Material Authorization” [R.M.A.]) from the factory.

NOTE: An R.M.A. is valid for only thirty (30) days from date of issue.

The R.M.A. issued by the factory, as well as any other correspondence pertaining to the returned part(s), **must be** included inside the package with the failed merchandise.

2. Each part **must be** tagged with the following information:
 - a. **Model number** and **serial number** of the dryer from which part was removed.
 - b. Nature of failure (be specific).
 - c. Date of dryer installation.
 - d. Date of part failure.
 - e. Specify whether the part(s) being returned is for a replacement, a credit, or a refund.

NOTE: If a part is marked for a credit or a refund, the invoice number covering the purchase of the replacement part **must be** provided.

NOTE: Warranty tags (ADC P/N 450064) are available at “no charge” from ADC upon request.

3. The company returning the part(s) must clearly note the complete company name and address on the outside of the package.
4. **ALL** returns **must be** properly packaged to ensure that they are not damaged in transit. *Damage claims are the responsibility of the shipper.*

IMPORTANT: No replacements, credits, or refunds **will be** issued for merchandise damaged in transit.

5. **ALL** returns **should be** shipped to the ADC factory in such a manner that they are insured and a proof of delivery can be obtained by the sender.
6. **Shipping charges are not the responsibility of ADC. ALL returns should be “prepaid” to the factory. Any “C.O.D.” or “COLLECT” returns will not be accepted.**

IMPORTANT: No replacements, credits, or refunds **will be** issued if the claim **cannot** be processed due to insufficient information. The party filing the claim **will be** notified in writing, either by “FAX” or “CERTIFIED MAIL - Return Receipt Requested,” as to the information necessary to process claim. If reply **is not** received by the ADC Warranty Department within thirty (30) days from the FAX/letter date, then no replacements, credits, or refunds **will be** issued, and the merchandise **will be** discarded.

SECTION VII

ROUTINE MAINTENANCE

A. CLEANING

A program and/or schedule **should be** established for periodic inspection, cleaning, and removal of lint from various areas of the dryer, as well as throughout the ductwork system. The frequency of cleaning can best be determined from experience at each location. Maximum operating efficiency is dependent upon proper air circulation. The accumulation of lint can restrict this airflow. If the guidelines in this section are met, an ADC dryer will provide many years of efficient, trouble free, and most importantly safe operation.

WARNING: LINT FROM MOST FABRICS IS HIGHLY COMBUSTIBLE. THE ACCUMULATION OF LINT CAN CREATE A POTENTIAL FIRE HAZARD.

WARNING: KEEP DRYER AREA CLEAR AND FREE FROM COMBUSTIBLE MATERIALS, GASOLINE, AND OTHER FLAMMABLE VAPORS AND LIQUIDS.

NOTE: Suggested time intervals shown are for average usage, which is considered six (6) to eight (8) operational (running) hours per day.

IMPORTANT: Dryer produces combustible lint and *must be* exhausted to the outdoors. Every 6 months, inspect the exhaust ducting and remove any lint buildup.

SUGGESTED CLEANING SCHEDULE

DAILY (beginning of each work shift)

Clean lint from lint drawer/screen.

Inspect lint screen and replace if torn.

WEEKLY

Clean lint accumulation from around microprocessor temperature sensor probes and sensor bracket assemblies.

WARNING: TO AVOID THE HAZARD OF ELECTRICAL SHOCK, DISCONTINUE ELECTRICAL SUPPLY TO THE DRYER.

90 DAYS

Inspect and remove lint accumulation in customer furnished exhaust ductwork system and from the dryer's internal exhaust ducting.

WARNING: THE ACCUMULATION OF LINT IN THE EXHAUST DUCTWORK CAN CREATE A POTENTIAL FIRE HAZARD.

WARNING: *DO NOT* OBSTRUCT THE FLOW OF COMBUSTION AND VENTILATION AIR.

WARNING: INSPECT AND REMOVE ANY LINT ACCUMULATION, WHICH CAN CAUSE THE BACK DRAFT DAMPER TO BIND OR STICK.

NOTE: A back draft damper that is sticking partially closed can result in slow drying and shutdown of the heat circuit safety switches and/or thermostats.

NOTE: When cleaning dryer cabinet(s), avoid using harsh abrasives. A product intended for the cleaning of appliances is recommended.

B. ADJUSTMENTS

7 DAYS AFTER INSTALLATION AND EVERY 6 MONTHS THEREAFTER

Inspect bolts, nuts, screws, setscrews, grounding connections, nonpermanent gas connections (unions, shutoff valves, and orifices), and examine wheels. Motor and drive belts **should be** examined. Cracked or seriously frayed belt(s) **should be** replaced. Tighten loose belts when necessary. Complete operational check of controls and valves. Complete operational check of **ALL** safety devices (door switches, lint drawer switch, sail switch, burner and hi-limit thermostats).

C. LUBRICATION

The motor bearings and under normal conditions the basket (tumbler) bearings are permanently lubricated.

THE DATA LABEL

1. MODEL NUMBER

The model number is an **ADC** number, which describes the size of the dryer and the type of heat (gas, electric, or steam).

2. SERIAL NUMBER

The serial number allows **ADC** to gather information on your particular dryer.

3. MANUFACTURING CODE NUMBER

The manufacturing code number is a number issued by **ADC**, which describes **ALL** possible options on your particular model.

4. TYPE OF HEAT

This describes the type of heat for your particular dryer: gas (either natural gas or liquid propane [L.P.] gas), electric, or steam.

5. HEAT INPUT (for GAS DRYERS)

This describes the heat input in British Thermal Units per Hour (Btu/hr).

6. ORIFICE SIZE (for GAS DRYERS)

Gives the number drill size used.

7. ELECTRIC SERVICE

This describes the electric service for your particular model.

8. GAS MANIFOLD PRESSURE (for GAS DRYERS)

This describes the manifold pressure taken at the gas valve tap.

SECTION IX

PROCEDURE FOR FUNCTIONAL CHECK OF REPLACEMENT COMPONENTS

1. Microprocessor Controller (Computer) Board

Phase 7 Coin/Non-Coin (Free Mode) Models

- a. Upon completing installation of the replacement microprocessor controller (computer) board, reestablish power to the dryer.
- b. Start the drying cycle by pressing any temperature selection keys (HI, MED, or LO).

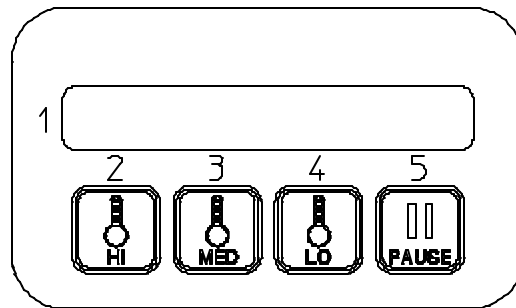

JM 9/17/13

MANG673

- c. Verify that the applicable indicator lights on the microprocessor controller (computer) board are lit. (Refer to the **illustration below.**)

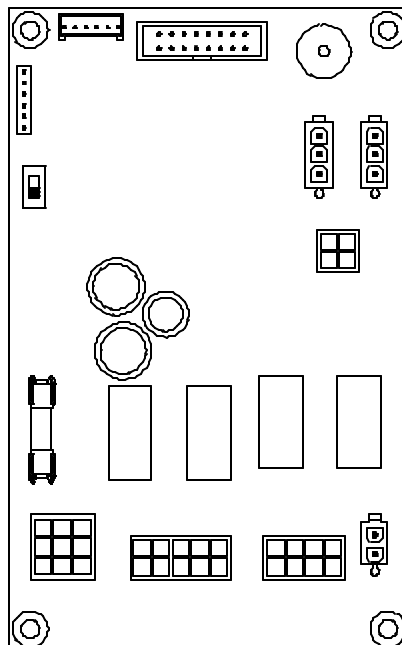

MANG675

JM 9/11/13

2. For Models With Johnson Controls Direct Spark Ignition (DSI) Module (G760)

Theory Of Operation:

Start the drying cycle. When the gas burner ignites within the chosen trial for ignition time (6-seconds), the flame sensor detects gas burner flame and signals the DSI module to keep the gas valve open as long as there is a call for heat. The DSI module will “LOCK OUT” if the gas burner flame is not sensed at the end of the trial for ignition period. The trial for ignition period will be repeated for a total of three (3) retries/trials (the initial try and two [2] more retries/trials). If the flame is not sensed at the end of the third retry/trial (inter-purge period of 30-seconds) the DSI module will “LOCK OUT” (light emitting diode [L.E.D.] flashes).

A steady L.E.D. indicator indicates normal operation.

No L.E.D. indicator indicates a power or an internal failure has occurred.

